



TOSHIBA



DVD HOME CINEMA KIT **SD-63HK**

OWNER'S MANUAL

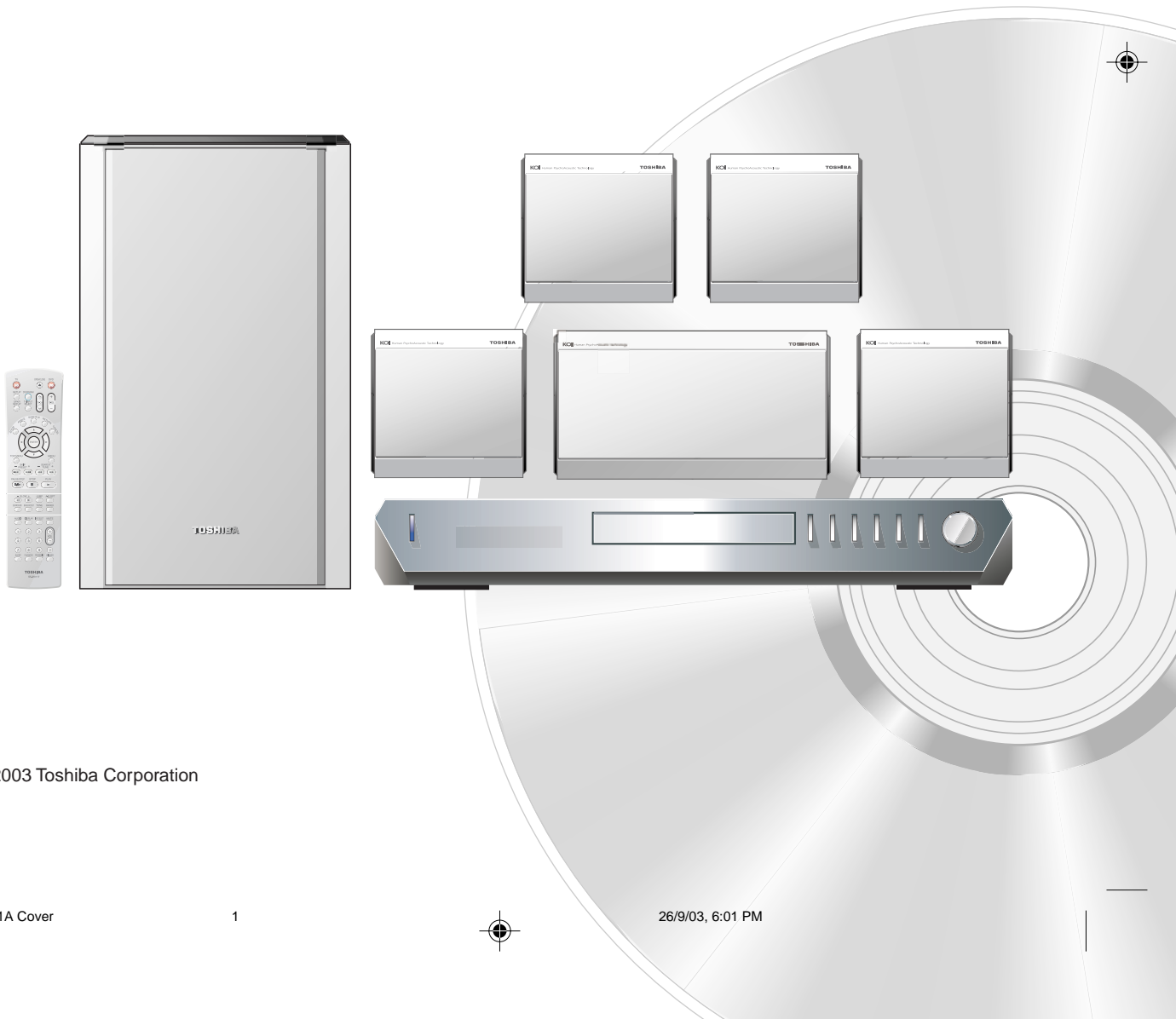

©2003 Toshiba Corporation



SAFETY PRECAUTIONS

WARNING: TO REDUCE THE RISK OF FIRE OR ELECTRIC SHOCK, DO NOT EXPOSE THIS APPLIANCE TO RAIN OR MOISTURE. DANGEROUS HIGH VOLTAGES ARE PRESENT INSIDE THE ENCLOSURE. DO NOT OPEN THE CABINET. REFER SERVICING TO QUALIFIED PERSONNEL ONLY.

CAUTION: This Digital Video Disc Player employs a Laser System. To ensure proper use of this product, please read this owner's manual carefully and retain for future reference. Should the unit require maintenance, contact an authorized service location -see service procedure.

Use of controls or adjustments or performance of procedures other than those specified herein may result in hazardous radiation exposure.

To prevent direct exposure to laser beam, do not try to open the enclosure. Visible and invisible laser radiation when open and interlocks defeated. DO NOT STARE INTO BEAM.

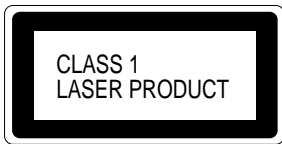

CAUTION: Servicing instructions are for use by qualified service personnel only. To reduce the risk of electric shock do not perform any servicing other than that contained in the operating instructions unless you are qualified to do so.

In the spaces provided below, record the Model and Serial No. located on the rear panel of your DVD video player.

Model No. _____

Serial No. _____

Retain this information for future reference.

The following information applies only to the model for U.K.

General Information

If the socket outlets in your home are not suitable for the plug supplied with this unit, the plug must be cut off and an appropriate one fitted.

The plug severed from this mains lead must be destroyed as it is hazardous if inserted into a live socket.

IMPORTANT

The wires in this mains lead are coloured in accordance with the following code:

BLUE: NEUTRAL

BROWN: LIVE

As the colours of the wires in the mains lead of this unit may not correspond with the coloured markings identifying the terminals in your plug, proceed as follows:

The wire that is coloured blue must be connected to the terminal in the plug which is marked with the letter N or coloured black.

The wire that is coloured brown must be connected to the terminal which is marked with the letter L or coloured red.

Do not connect either wire to the earth terminal which is marked by the letter E or by the safety earth symbol  or coloured green or green-and-yellow.

Use a 5A fuse which is approved by ASTA or BSI to BS1362.

Always replace the fuse cover after changing the fuse.

Location of the required label

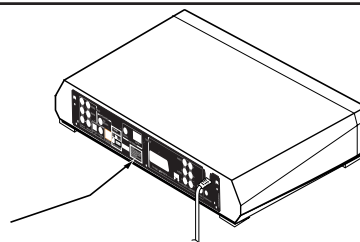

The rating plate and the safety caution are on the rear of the unit.

2





SOME DOS AND DON TS ON THE SAFE USE OF EQUIPMENT

This equipment has been designed and manufactured to meet international safety standards but, like any electrical equipment, care must be taken if you are to obtain the best results and safety is to be assured.

DO read the operating instructions before you attempt to use the equipment.

DO ensure that all electrical connections (including the mains plug, extension leads and inter- connections between the pieces of equipment) are properly made and in accordance with the manufacturer's instructions. Switch off and withdraw the mains plug before making or changing connections.

DO consult your dealer if you are ever in doubt about the installation, operation or safety of your equipment.

DO be careful with glass panels or doors on equipment

DON'T remove any fixed cover as this may expose dangerous voltages.

DON'T obstruct the ventilation openings of the equipment with items such as newspapers, tablecloths, curtains, etc. Overheating will cause damage and shorten the life of the equipment.

DON'T allow electrical equipment to be exposed to dripping or splashing, or objects filled with liquids, such as vases, to be placed on the equipment.

DON'T place hot objects or naked flame sources such as lighted candles or nightlights on, or close to equipment. High temperatures can melt plastic and lead to fires.

DON'T use makeshift stands and NEVER fix legs with wood screws - to ensure complete safety always fit the manufacturer's approved stand or legs with the fixings provided according to the instructions.

DON'T use equipment such as personal stereos or radios so that you are distracted from the requirements of traffic safety. It is illegal to watch television whilst driving.

DON'T listen to headphones at high volume, as such use can permanently damage your hearing.

DON'T leave equipment switched on when it is unattended unless it is specifically stated that it is designed for unattended operation or has a stand-by mode. Switch off using the switch on the equipment and make sure that your family know how to do this. Special arrangements may need to be made for infirm or handicapped people.

DON'T continue to operate the equipment if you are in any doubt about it working normally, or if it is damaged in any way -switch off, withdraw the mains plug and consult your dealer.

ABOVE ALL

—NEVER let anyone especially children push anything into holes, slots or any other opening in the case - this could result in a fatal electrical shock;

—NEVER guess or take chances with electrical equipment of any kind

—it is better to be safe than sorry!





Precautions

Notes on handling

- When shipping the unit, the original shipping carton and packing materials come in handy. For maximum protection, repack the unit as it was originally packed at the factory.
- Do not use volatile liquids, such as insect spray, near the unit. Do not leave rubber or plastic products in contact with the unit for a long time. They will leave marks on the finish.
- The top and rear panels of the DVD video player may become warm after a long period of use. This is not a malfunction.
- When the DVD video player is not in use, be sure to remove the disc and turn off the power.
- If you do not use the unit for a long period, it may not function properly in the future. Turn on and use the unit occasionally.

Notes on locating

- Place the unit on a level surface. Do not use it on a shaky or unstable surface such as a wobbling table or inclined stand. The loaded disc may come off the proper position and cause damage to the DVD video player.
- When you place this unit near a TV, radio, or VCR, the playback picture may become poor and the sound may be distorted. In this case, place the unit away from the TV, radio, or VCR.

Notes on cleaning

- Use a soft, dry cloth for cleaning.
- For stubborn dirt, soak the cloth in a weak detergent solution, wring well and wipe. Use a dry cloth to wipe it dry.
Do not use any type of solvent, such as thinner and benzene, as they may damage the surface of the unit.
- If you use a chemical saturated cloth to clean the unit, follow that product's instructions.

To obtain a clear picture

The unit is a high technology, precision device. If the optical pick-up lens and disc drive parts are dirty or worn down, the picture quality becomes poor. To obtain a clear picture, we recommend regular inspection and maintenance (cleaning or parts replacement) every 1,000 hours of use depending on the operating environment. For details, contact your nearest dealer.

Notes on moisture condensation

Moisture condensation damages the DVD video player. Please read the following carefully.

Moisture condensation occurs, for example, when you pour a cold drink into a glass on a warm day. Drops of water form on the outside of the glass. In the same way, moisture may condense on the optical pick-up lens inside this unit, one of the most crucial internal parts of the DVD video player.

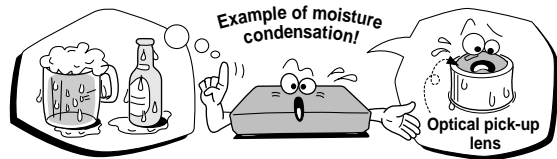

Moisture condensation occurs during the following cases:

- When you bring the DVD video player directly from a cold place to a warm place.
- When you use the DVD video player in a room where you just turned on the heater, or a place where the cold wind from the air conditioner directly hits the unit.
- In summer, when you use the DVD video player in a hot and humid place just after you move the unit from an air conditioned room.
- When you use the DVD video player in a humid place.

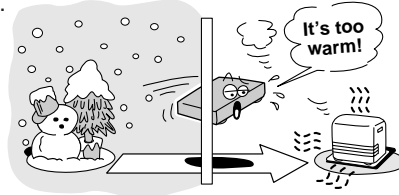

Do not use the DVD video player when moisture condensation may occur.

If you use the DVD video player in such a situation, it may damage discs and internal parts. Remove the disc, connect the mains lead of the DVD video player to the wall outlet, turn on the DVD video player, and leave it for two or three hours. After two or three hours, the DVD video player will have warmed up and evaporated any moisture. Keep the DVD video player connected to the wall outlet and moisture condensation will seldom occur.

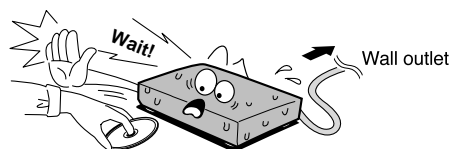



Notes on discs

On handling discs

- Do not touch the playback side of the disc.

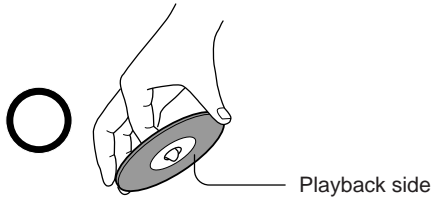

- Do not attach paper or tape to discs.



On cleaning discs

- Fingerprints and dust on the disc cause picture and sound deterioration. Wipe the disc from the centre outwards with a soft cloth. Always keep the disc clean.

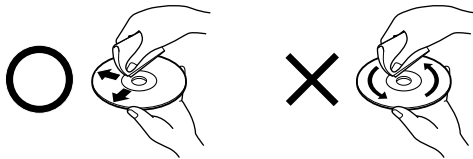

- If you cannot wipe off the dust with a soft cloth, wipe the disc lightly with a slightly moistened soft cloth and finish with a dry cloth.
- Do not use any type of solvent such as thinner, benzine, commercially available cleaners or antistatic spray for vinyl LPs. It may damage the disc.

On storing discs

- Do not store discs in a place subject to direct sunlight or near heat sources.
- Do not store discs in places subject to moisture and dust such as a bathroom or near a humidifier.
- Store discs vertically in a case. Stacking or placing objects on discs outside of their case may cause warping.

Structure of disc contents

Normally, DVD video discs are divided into titles, and the titles are sub-divided into chapters. VIDEO CDs and AUDIO CDs are divided into tracks.

DVD video disc

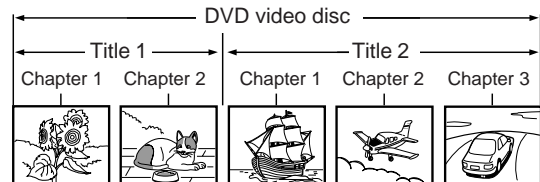

VIDEO CD/AUDIO CD

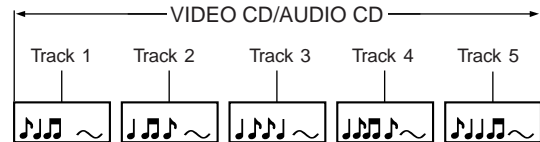

Each title, chapter or track is assigned a number, which is called "title number", "chapter number" or "track number" respectively.

There may be discs that do not have these numbers.

Notes on copyright

It is forbidden by law to copy, broadcast, show, broadcast on cable, play in public, and rent copyrighted material without permission.

DVD video discs are copy protected, and any recordings made from these discs will be distorted.

This product incorporates copyright protection technology that is protected by method claims of certain U.S. patents and other intellectual property rights owned by Macrovision Corporation and other rights owners. Use of this copyright protection technology must be authorized by Macrovision Corporation, and is intended for home and other limited viewing uses only unless otherwise authorized by Macrovision Corporation. Reverse engineering or disassembly is prohibited.





Notes on discs

(continued)

About this owner's manual

This owner's manual explains the basic instructions of this DVD video player. Some DVD video discs are produced in a manner that allows specific or limited operation during playback. As such, the DVD video player may not respond to all operating commands. This is not a defect in the DVD video player. Refer to instruction notes of discs.

“” may appear on the TV screen during operation. A “” means that the operation is not permitted by the DVD video player or the disc at the moment. For example, sometimes it is unable to stop the playback of copyright message of the disc when the STOP (■) button is pressed. Alternatively, the “” may also indicate that the feature is not available for the disc.

Notes on region numbers

The region number of this DVD video player is 2. If region numbers, which stand for their playable area, are printed on your DVD video disc and you do not find or , disc playback will not be allowed by the player. (In this case, the DVD video player will display a message on-screen.)

On VIDEO CDs

This DVD video player supports VIDEO CDs equipped with the PBC (Version 2.0) function. (PBC is the abbreviation of Playback Control.) You can enjoy two playback variations depending on types of discs.

- **VIDEO CD not equipped with PBC function (Version 1.1)**
Sound and movie can be played on this DVD video player in the same way as an audio CD.
- **VIDEO CD equipped with PBC function (Version 2.0)**
In addition to operation of a VIDEO CD not equipped with the PBC function, you can enjoy playback of interactive software with search function by using the menu displayed on the TV screen (Menu Playback). Some of the functions described in this owner's manual may not work with some discs.

Playable discs

This DVD video player can play the following discs.

	Disc Mark	Contents	Disc Size	Maximum playback time
DVD video discs		Audio + video (moving pictures)	12 cm	Approx. 4 hours (single sided disc)
				Approx. 8 hours (double sided disc)
			8 cm	Approx. 80 minutes (single sided disc)
				Approx. 160 minutes (double sided disc)
VIDEO CDs		Audio + video (moving pictures)	12 cm	Approx. 74 minutes
			8 cm	Approx. 20 minutes
Audio CDs		Audio	12 cm	Approx. 74 minutes
			8 cm (CD single)	Approx. 20 minutes

The following discs are also available.

- CD-TEXT discs
 - DVD-R discs of DVD video format
 - CD-R/CD-RW discs of CD-DA, VIDEO CD, SVCD, MP3, WMA or JPEG format
 - KODAK Picture CD and FUJICOLOR CD format
- Some of these discs may be incompatible.

- You cannot play discs other than those listed above.
- You cannot play discs of DVD-RAM, DVD-RW, Photo CD, CVD, or non-standardized discs, etc., even if they may be labeled as above.
- This DVD video player uses the PAL (or NTSC) colour system, and cannot play DVD video discs recorded in SECAM colour system.
- NTSC DVD or VCD discs will be playback in black and white if PAL only TV is used.



Table of contents

● SAFETY PRECAUTIONS	2	● Playback procedure	25
● Precautions	4	Basic playback	25
● Notes on discs	5	Special playback	26
● Table of contents	7	Locating a chapter or track	26
● Identification of controls	8	Picture zoom	26
Front panel	8	Marking the scenes	27
Rear panel	8	Returning to the scenes	27
Display window	9	Locating desired scene	27
Remote control	10	Title, Chapter and Track Repeat playback	28
Loading batteries	11	A-B Repeat playback	28
Operating with the remote control	11	Programme playback	29
● Connections	12	Random playback	29
Connecting to a TV	12	Changing angles	29
FM/AM aerial connection	13	Title selection	30
Connecting to optical equipment	13	DVD menu	30
Speaker system connection	14	Changing soundtrack language	30
Speaker position	14	Subtitles	30
● Audio setup	15	Disc status	31
Tone control	15	To turn off the PBC	31
Bass boost setting	15	● MP3/WMA/JPEG CD operation	32
Selecting surround mode	16	MP3/WMA/JPEG CD information	32
Speaker setup	17	MP3/WMA CD playback	33
● DVD setup	18	JPEG CD playback	34
Setting OSD language	18	Slide show playback	34
Setting Menu language	18	● Progressive scan	35
Setting Subtitle language	19	Selecting progressive scan	35
Setting Audio soundtrack language	19	● Radio operation	36
Setting the aspect ratio of TV screen	20	Tuning the radio stations	36
Setting on screen display	20	Presetting the radio stations	36
Setting JPEG Interval	21	Listening to the radio	37
Setting Select Files	21	Reception of RDS (Radio Data System) stations	37
Dynamic Range Control (DRC)	22	● Other functions	38
Line1 select	22	Sleep timer	38
Parental control setting	23	Dimmer	38
To change the parental level	23	Mute	38
● Language code list	24	Using headphone socket	38
		Selecting input source	38
		Screen saver	38
		● Before calling service personnel	39
		● Specifications	Backcover



Identification of controls

See the page in  for details.

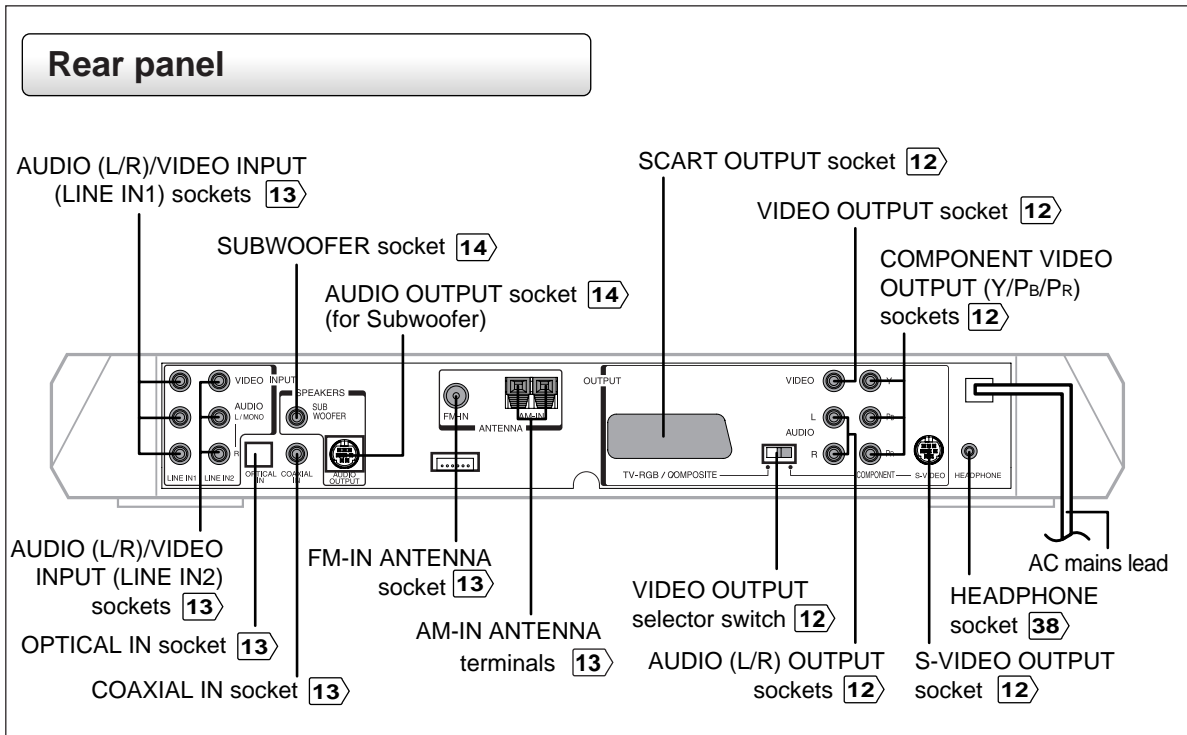
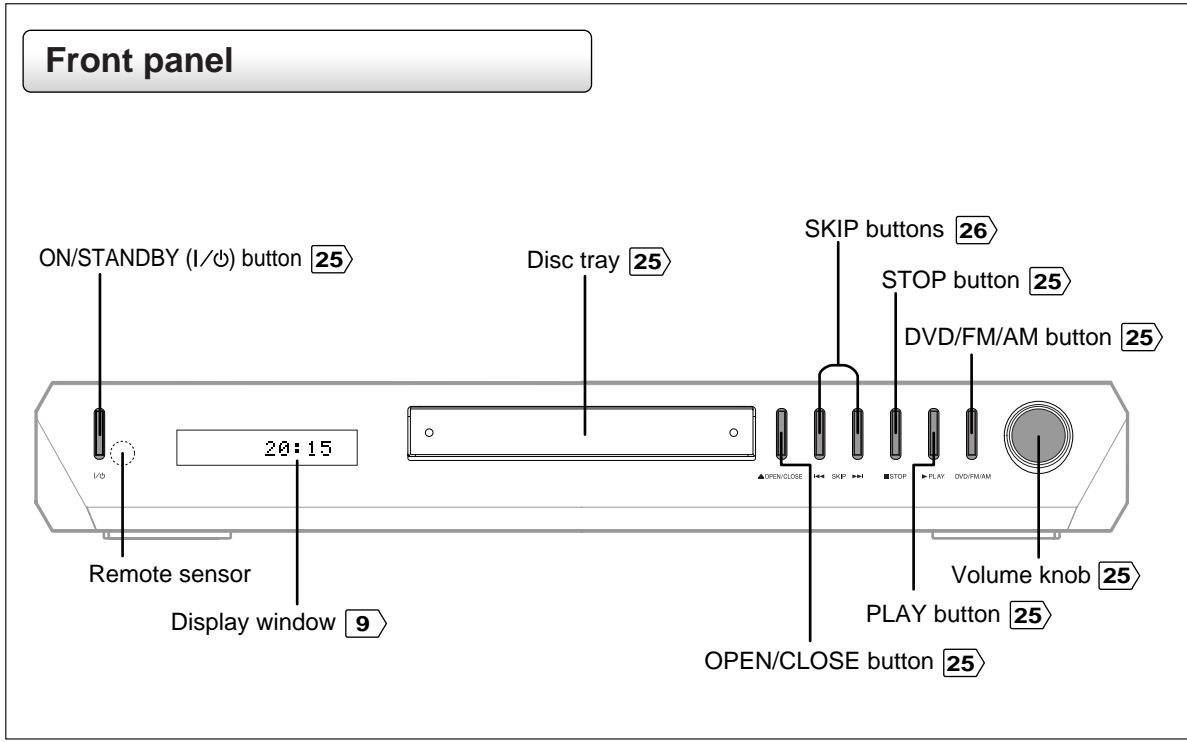



Display window

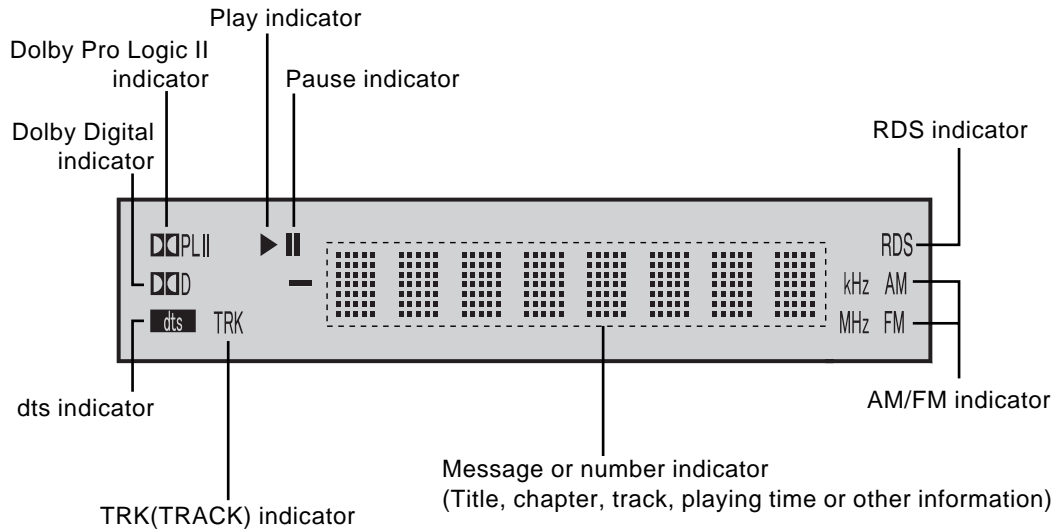

The display may vary depending on the types of discs you play.

DVD video disc	Video CD	Audio CD
<ul style="list-style-type: none"> • During playback: <p>Example</p> <p>Some discs may not display elapsed time.</p>	<ul style="list-style-type: none"> • During playback: <p>Example</p> <p>Playing track 1</p> <p>Some discs may not display track numbers or elapsed time.</p>	<ul style="list-style-type: none"> • During playback: <p>Example</p> <p>Playing track 7</p> <p>Some discs may not display track numbers or elapsed time.</p>





Identification of controls (continued)

The instructions in this manual describe the functions on the remote control.
See the page in for details.

Remote control

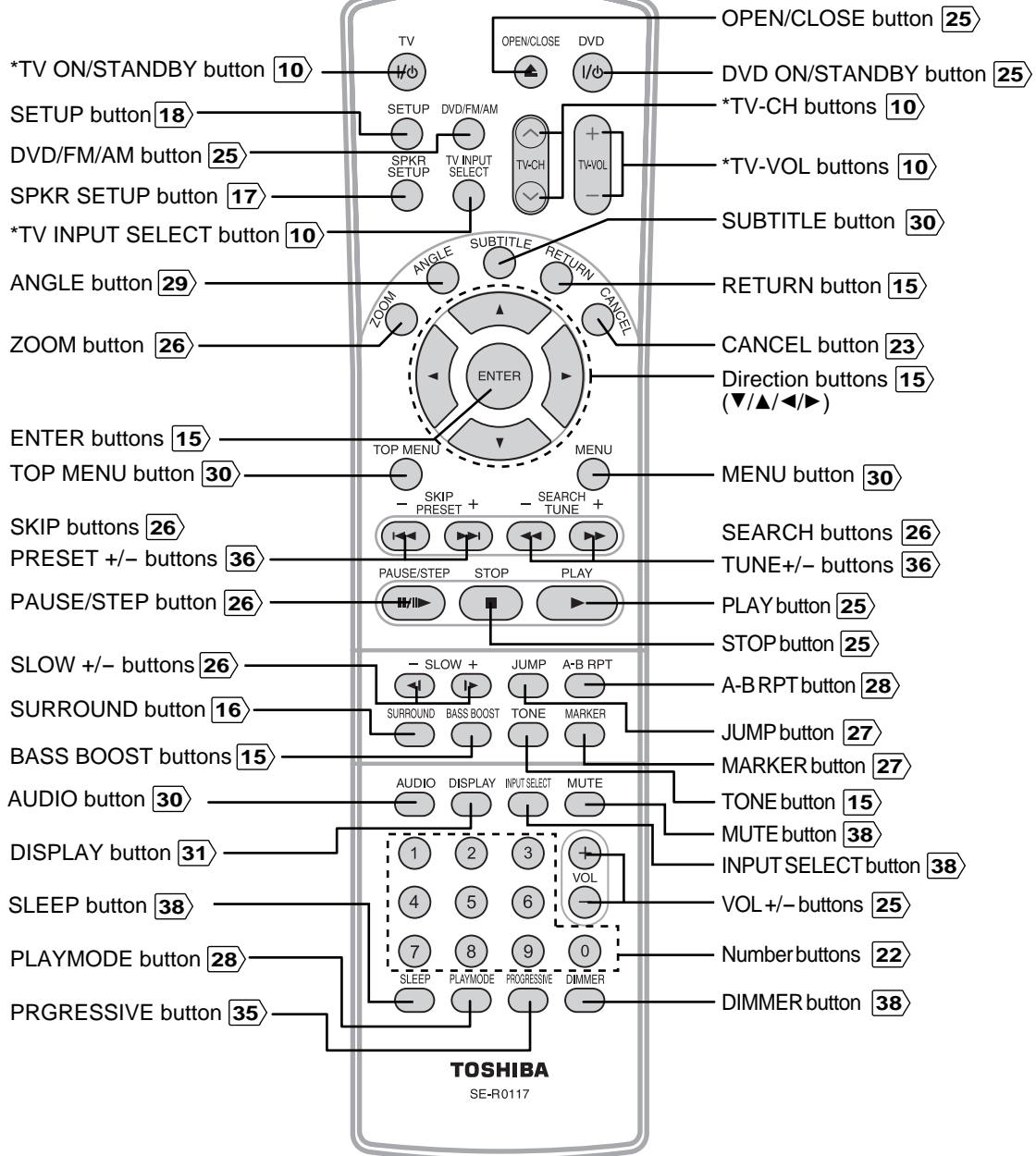

*TV control buttons

Only TOSHIBA TVs can be operated with this remote control.

There may be some TV models that cannot be operated with this remote control. If this is the case, use the original remote control supplied with the TV.





Loading batteries

- 1** Slide the battery compartment cover in the direction of the arrow.

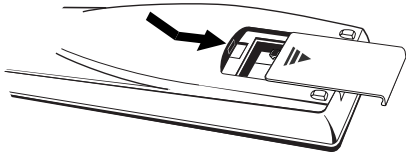

- 2** Install two "R03" batteries (supplied), paying attention to the polarity diagram in the battery compartment.

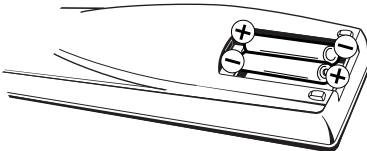

- 3** Replace the compartment cover.

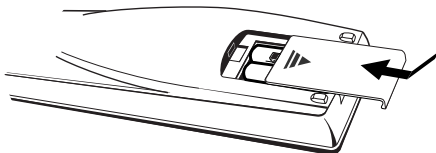

Notes on batteries

Improper use of batteries may cause battery leakage and corrosion. To operate the remote control correctly, follow the instructions below.

- Do not insert batteries into the remote control in the wrong direction.
- Do not charge, heat, open, or short-circuit the batteries. Do not throw batteries into a fire.
- Do not leave dead or exhausted batteries in the remote control.
- Do not use different types of batteries together, or mix old and new batteries.
- If you do not use the remote control for a long period of time, remove the batteries to avoid possible damage from battery corrosion.
- If the remote control does not function correctly or if the operating range becomes reduced, replace all batteries with new ones.
- If battery leakage occurs, wipe the battery liquid from the battery compartment, then insert new batteries.

Operating with the remote control

- Point the remote control at the remote sensor and press the buttons.**

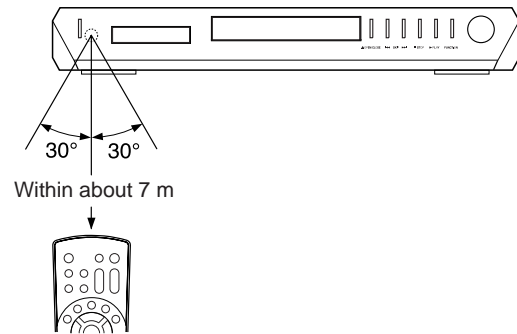

- Distance: About 7 m from the front of the remote sensor
Angle: About 30° in each direction of the front of the remote sensor

- * Do not expose the remote sensor of the unit to a strong light source such as direct sunlight or other illumination. If you do so, you may not be able to operate the unit via the remote control.

Notes on the remote control

- Direct the remote control at the remote sensor of the unit.
- Do not drop or give the remote control a shock.
- Do not leave the remote control near an extremely hot or humid place.
- Do not spill water or put anything wet on the remote control.
- Do not open the remote control.
- When using the remote control, press the button at intervals of about 1 second to ensure the correct mode of operation.



Connections

When you connect the unit to other equipment, be sure to turn off the power and unplug all of the equipment from the wall outlet before making any connections.

Connecting to a TV

Connect the unit directly to your TV. If you connect the unit to a VCR, TV/VCR combination or video selector, the DVD playback picture may be distorted as DVD video discs are copy protected.

Note: The S-video output and component video output transports the DVD-video signal exclusively and will deliver enhanced DVD video picture performance.

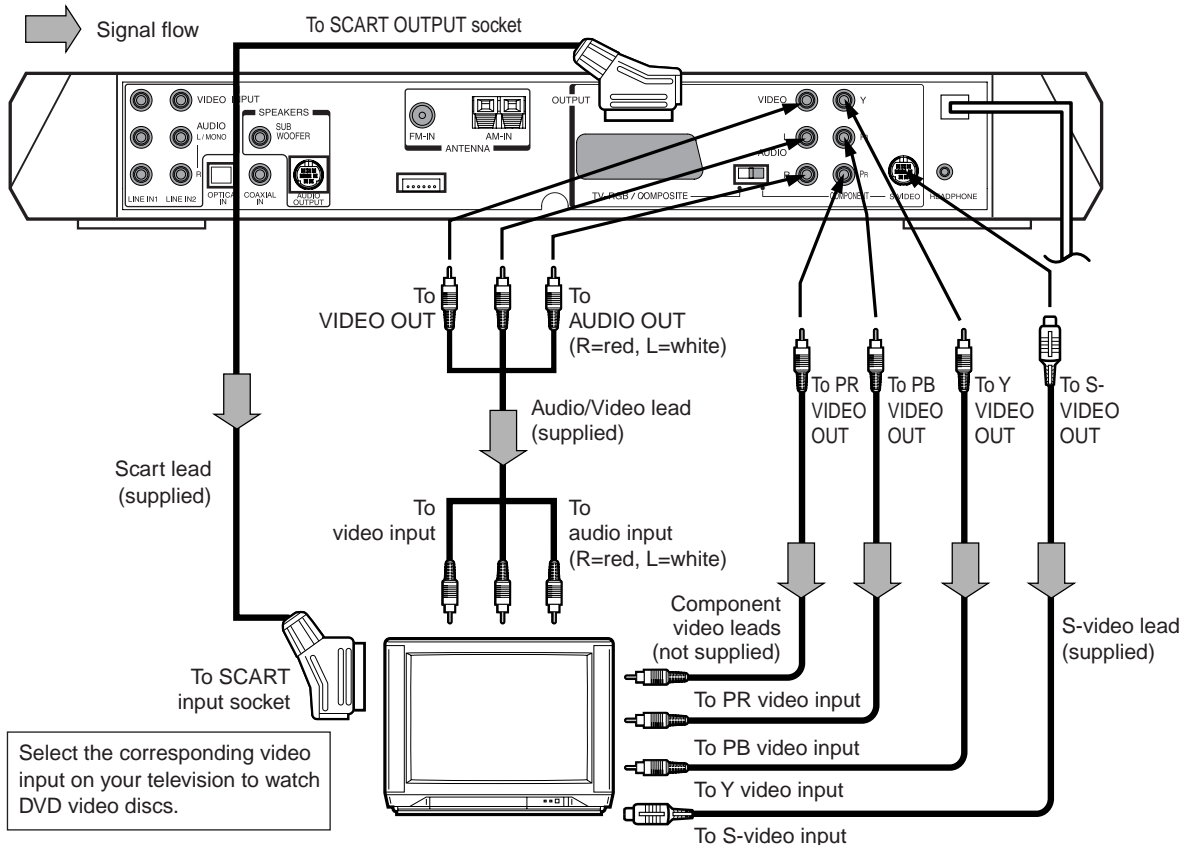

Make one of following connections depending on your TV.

■ SCART connection

Connect the SCART OUTPUT socket on the unit to the SCART INPUT socket on the TV using supplied SCART lead.

Note: If your TV is RGB compatible, slide the VIDEO OUTPUT selector to left side for better picture quality.

■ Video connection

Connect the AUDIO (L/R) and VIDEO OUTPUT sockets on the unit to the AUDIO (L/R) and VIDEO INPUT sockets on the TV using supplied Audio/Video lead.

■ S-Video connection

Connect the S-VIDEO OUTPUT socket on the unit to the S-VIDEO INPUT socket on the TV using supplied S-Video lead.

Connect the AUDIO (L/R) OUTPUT sockets on the unit to the AUDIO (L/R) INPUT sockets on the TV using Audio lead (not supplied).

Note: Slide the VIDEO OUTPUT selector to right side.

■ Component Video (Color Stream®) connection

Connect the COMPONENT OUTPUT sockets on the unit to the COMPONENT INPUT sockets on the TV using supplied Component lead (not supplied). Connect the AUDIO (L/R) OUTPUT sockets on the unit to the AUDIO (L/R) INPUT sockets on the TV using Audio lead (not supplied).

Note: Slide the VIDEO OUTPUT selector to right side.

Notes:

- Refer to the owner's manual of the connected equipment as well.
- If you place the unit near a tuner or radio, the radio broadcast sound might be distorted. In this case, place the unit away from the tuner and radio.
- The output sound of the unit has a wide dynamic range. Be sure to adjust the volume to a moderate listening level. Otherwise, the speakers may be damaged by a sudden high volume sound.
- If your television set has one audio input, connect the unit to a Y lead adapter (not supplied) and then connect to your TV.





FM/AM aerial connections

Connect the supplied FM/AM aerials for listening to the radio.

- Connector the FM wire aerial to the FM-IN ANTENNA socket.
- Connect the AM loop aerial to the AM-IN ANTENNA terminals.

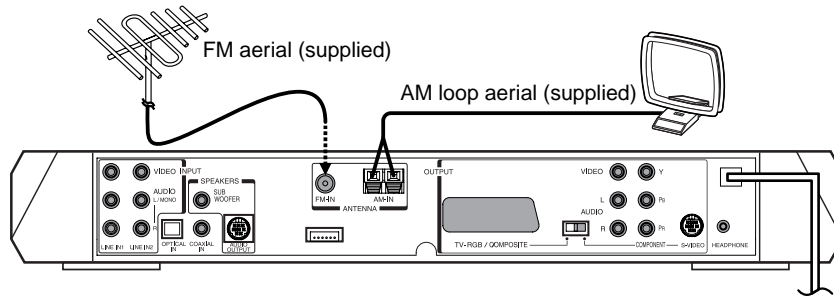

Notes:

- To prevent noise pickup, keep the AM loop aerial away from the unit and other component.
- Be sure to fully extend the FM wire aerial.
- After connecting the FM wire aerial, keep it as horizontal as possible.

Connecting to optional equipment

You can also enjoy high quality dynamic sounds of an optional equipment by connecting with this unit.

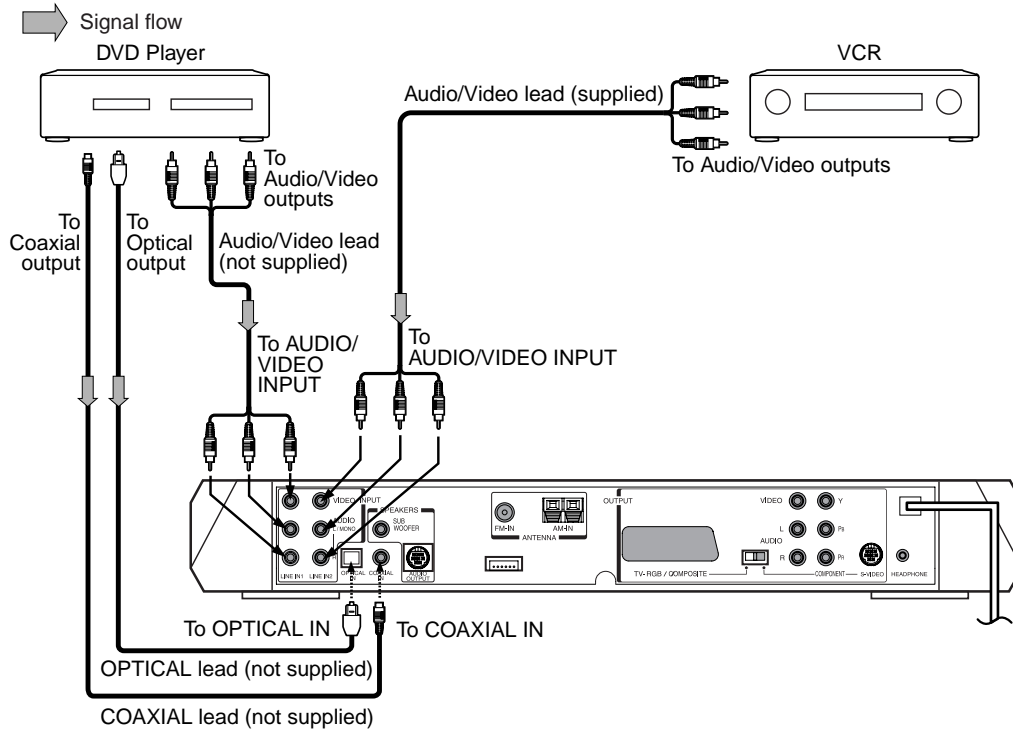

- The OPTICAL IN and COAXIAL IN sockets are belong to LINE IN 1 input.
If you connect the DVD player using a Optical lead or Coaxial lead, the Video lead must be connected to LINE IN1 VIDEO INPUT socket.
- If you connect your VCR or DVD player to LINE IN 1 sockets, you must set "LINE 1 select" setting to the appropriate position. (See page 22.)

Notes:

- Refer to the owner's manual of the connected equipment as well.
- If you place the unit near a tuner or radio, the radio broadcast sound might be distorted. In this case, place the unit away from the tuner and radio.
- The output sound of the unit has a wide dynamic range. Be sure to adjust the volume to a moderate listening level. Otherwise, the speakers may be damaged by a sudden high volume sound.





Speaker system connection

Turn off the mains first and set the volume knob to low initially before connecting. Connect the speakers using the supplied speaker leads by matching the colors of the terminals and those of the leads. To obtain the best possible surround sound, adjust the speaker parameters (distance, level etc.).

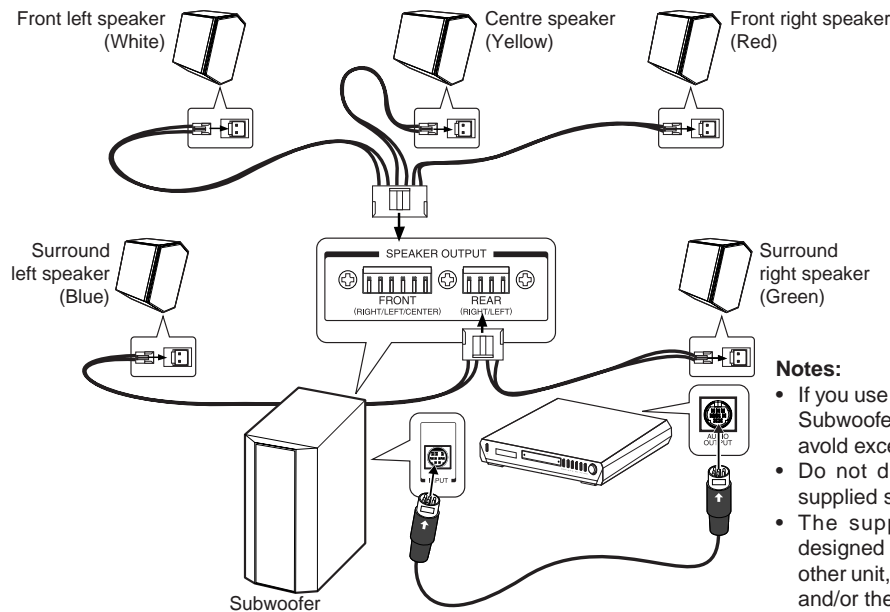

Notes:

- If you use the BASS LEVEL control on the Subwoofer, adjust the volume carefully to avoid excessive output on the speakers.
- Do not disassemble the front cover of supplied speaker.
- The supplied speakers or leads are designed only for this unit. Never use for other unit, or it should damage the speaker and/or the unit.

Speaker position

In the case of normal position use the 6 speakers (2 front speakers, centre, 2 rear speakers and subwoofer).

■ Front speakers

We recommend that the height of the tweeter of the front speakers and listener's ears are same height. And by hearing position set up the interval between speakers to 45 degree.

■ Centre speaker

It is ideal that the centre speakers and front speakers are same height. But in normally place it above or below the television.

■ Rear speakers

Place left and right behind the listening area. These speakers recreate sound motion and atmosphere. Required for surround playback. For best results, do not install the rear speakers too far behind the listening position and install them at or above the level of the listener's ears. It is also effective to direct the rear speakers towards a wall or ceiling to further disperse the sound. In case of the small sizes from the front to rear of the room, if the listener is near the rear wall set the rear speakers opposite each other, and set the rear speakers above 60 - 90 cm then the listener's ears, and set up it looks down.

■ Subwoofer

We recommend place it near the front speaker.

To fix the speakers

Example

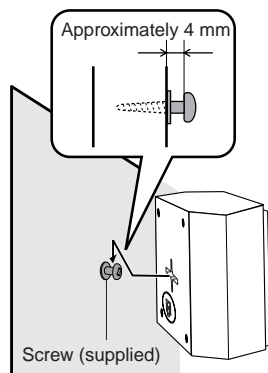

To avoid the damage or scratch

Example

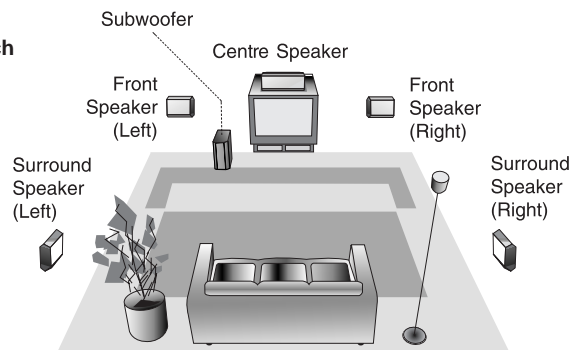
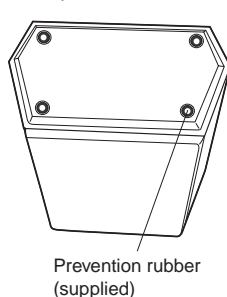

Speaker Positioning Example

Note: Take care when installing the speakers. They may cause damage or serious injury should they fall from their mountings.





Audio setup

Tone control

You can change the sound quality by adjusting the bass and treble.

- 1 Press **TONE** in DVD mode. The "Tone" screen appears.



- 2 Press **▲** or **▼** to select "Bass" or "Treble", then press **◀** or **▶** to adjust the sound level.



- 3 Press **TONE** or **RETURN** to close the "Tone" screen.



You can also adjust bass and treble setting in FM/AM or external input mode as follows.

1. Press **TONE**. The setting display appears on the display window.



Bass/Treble: -5 ~ +5

2. Press **▲** or **▼** to select "BASS" or "TREBLE".
3. Press **◀** or **▶** to adjust the sound level.
4. If setting is complete, press **TONE** or **ENTER**.

Bass boost setting

You can set bass boost effect on or off.

- 1 Press **BASS BOOST** in DVD mode. The "Bass Boost" screen appears.

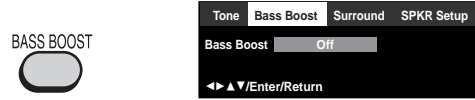

- 2 Press **▶** or **ENTER**, then press **▲** or **▼** to select "On" or "Off".

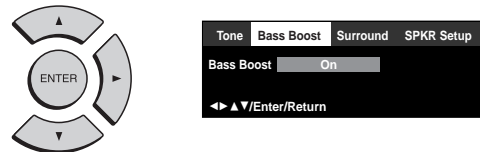

- 3 Press **BASS BOOST** or **RETURN** to close the "Bass Boost" screen.



You can also set bass boost setting in FM/AM or external input mode as follows.

1. Press **BASS BOOST**. The setting display appears on the display window.



2. Press **◀** or **▶** to set bass boost "ON" or "OFF".
3. If setting is complete, press **BASS BOOST** or **ENTER**.





Selecting surround mode

You can enjoy surround sound by selecting surround mode.

- 1 Press **SURROUND** in DVD mode. The "Surround" screen appears.

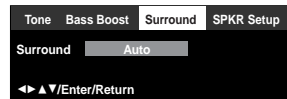

- 2 Press **▶** or **ENTER**, and press **▲** or **▼** to select "Auto", "PLII" or "2 Channel", then press **ENTER**.

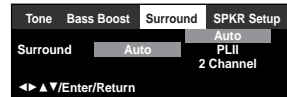
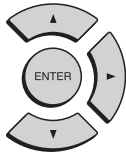

- 3 Press **SURROUND** or **RETURN** to close the "Surround" screen.



You can also select surround mode in FM/AM or external input mode as follows.

1. Press **SURROUND**. The setting display appears on the display window.



2. Press **▲** or **▼** to select "AUTO", "PLII" or "2CH"
3. If setting is complete, press **SURROUND** or **ENTER**.

Notes:

- There is no Dolby Surround effect when monaural programme material is used.
- When receiving weak FM broadcasts, set it to "2 Channel". The sound quality may improve.

Auto (AUTO)

The unit selects surround mode automatically depending on the disc.

- **Dolby Digital**
"DOLBY DIGITAL" appears on the display window. You can enjoy up to 5.1 channels of digital surround.
- **Digital Theater System (DTS)**
"DTS" appears on the display window. You can enjoy 5.1 channels of high quality digital audio.
- **Other source (PCM, CD, AM/FM, etc.)**
The surround mode is set to 2.1 channel. (Front left/right and Subwoofer)

PLII (PLII)

"DOLBY PLII" appears on the display window.

The unit sets all 2 channels sources to Dolby Pro Logic II mode. If the source is encoded with Dolby Digital 3, 4 or 5.1 channels or DTS, the surround mode is set to the original one.

2 Channel (2 CH)

The surround mode is set to 2.1 channel. (Front left/right and Subwoofer)

■ Dolby Digital

Dolby Digital is the surround sound technology used in theaters showing the latest movies, and is now available to reproduce this realistic effect in the home. You can enjoy motion picture and live concert DVD video discs with this dynamic realistic sound.

■ Dolby ProLogic II

You can enjoy the dynamic realistic sound of Dolby Surround Pro Logic Pro Logic II. Pro Logic II gives you multi channel surround sound from any stereo source - CDs, MP3 or WMA disc, tapes, FM broadcasts, etc. You will get the realistic, involving sound you'd expect from a 5.1-channel system.

Manufactured under license from Dolby Laboratories. "Dolby" "Pro Logic" and the double-D symbol are trademarks of Dolby Laboratories.

■ Digital Theater System (DTS)

DTS is a high quality surround technology used in theaters and now available for home use, on DVD video discs or audio CDs.

You can obtain the full benefit of 5.1 channel DTS encoded sound tracks on DVD video discs or audio CDs.

"DTS" and "DTS Digital Surround" are registered trademarks of Digital Theater Systems, Inc.





Speaker setup

You may adjust speaker volume balance and delay time according to your listening position.

Press **SPKR SETUP** in DVD mode.
The "SPKR Setup" screen appears.
Press \blacktriangle or \blacktriangledown to select "Volume", "Test Tone", "Centre Delay" or "Surround Delay".

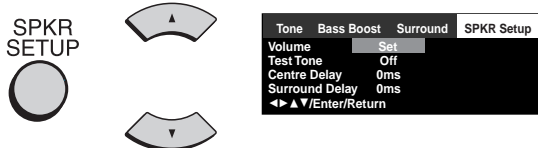

■ Volume

You can adjust the volume level of each speaker.
1. Press **ENTER** or \blacktriangleright . The "Volume" screen appears.

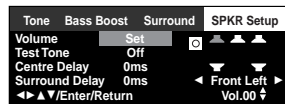

2. Press \blacktriangleleft or \blacktriangleright to select the desired speaker.
3. Press \blacktriangle or \blacktriangledown to adjust the volume level as desired ("0" ~ "-10").
4. Repeat steps 2 ~ 3 for other speakers.
5. Press **SPKR SETUP** or **RETURN** to close the "SPKR Setup" screen.

You can also adjust the volume level of each speaker in FM/AM or external input mode as follows.

1. Press **SPKR SETUP**. The setting display appears on the display windows.



2. Press \blacktriangle or \blacktriangledown to select the desired speaker.
3. Press \blacktriangleleft or \blacktriangleright to adjust the volume level as desired ("0" ~ "-10").
4. If adjusting is complete, press **SPKR SETUP** or **ENTER**.

■ Test Tone

You can adjust the sound balance of the speakers.
1. Press **ENTER** or \blacktriangleright . The "Test Tone" screen appears. The test tone comes out for 3 seconds from each speakers in the following order.

Front Left \rightarrow Centre \rightarrow Front Right \rightarrow Rear Right
 \rightarrow Rear Left \rightarrow Sub Woofer \rightarrow Front Left \rightarrow ...

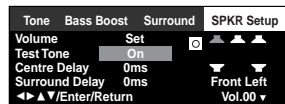

2. If the test tone balance is not kept, press \blacktriangle or \blacktriangledown to adjust the volume level as desired ("0" ~ "-10") while the desired speaker is activating.
3. Repeat step 2 for other speakers.
4. Press **SPKR SETUP** or **RETURN** to close the "SPKR Setup" screen.

It is hopeful that the interval from the listener to each speakers is same to get the best sound quality. If not, you can adjust the delay time so that the sounds from speakers will arrive simultaneously to the listener.

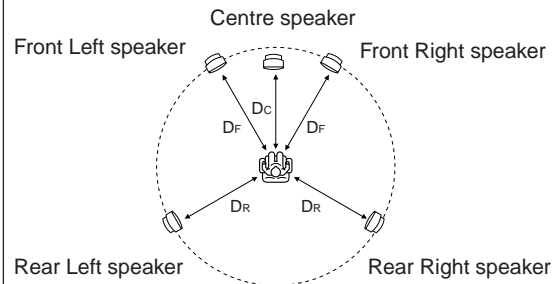

■ Centre Delay

If the distance of D_c is equal or longer than D_f , set the delay time to "0ms" using \blacktriangleleft or \blacktriangleright .

If the distance of D_c is shorter than D_f , set the Centre Delay time using \blacktriangleleft or \blacktriangleright as follows.

$D_f - D_c$	Setting
30cm (approx.)	1ms
60cm (approx.)	2ms
90cm (approx.)	3ms
120cm (approx.)	4ms
150cm (approx.)	5ms

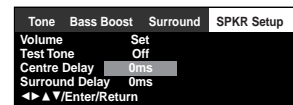

■ Surround Delay

If the distance of D_r is equal or longer than D_f , set the delay time to "0ms" using \blacktriangleleft or \blacktriangleright .

If the distance of D_r is shorter than D_f , set the Surround Delay time using \blacktriangleleft or \blacktriangleright as follows.

$D_f - D_r$	Setting
150cm (approx.)	5ms
300cm (approx.)	10ms
450cm (approx.)	15ms

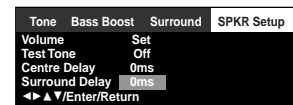

Press **SPKR SETUP** or **RETURN** to close the "SPKR Setup" screen.



DVD setup

When each setup function (page 18 ~ 24) has been completed, the unit can always be operated under the same conditions (especially with DVD discs).

Each setup command will be retained in the memory even if you turn the power off.

Setting OSD language

The setup language can be selected.

- 1 Press **SETUP** in the stop mode. Press **▼** or **ENTER**, then press **▲** or **▼** to select "OSD".

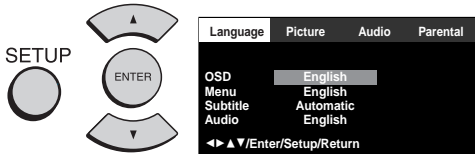

- 2 Press **▶** or **ENTER**, then press **▲** or **▼** to select your desired language.

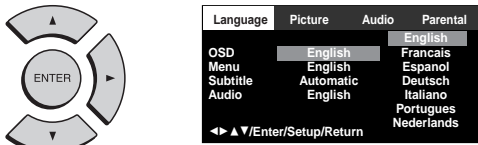

- 3 Press **ENTER**. The selected language remains.



- 4 Press **SETUP** or **RETURN** to close the screen.



Setting Menu language

You can select the language of the DVD disc menu display.

- 1 Press **SETUP** in the stop mode. Press **▼** or **ENTER**, then press **▲** or **▼** to select "Menu".

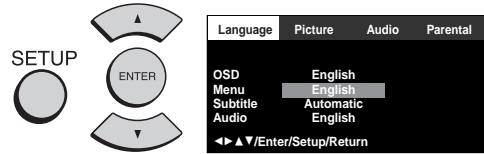

- 2 Press **▶** or **ENTER**. Press **▲** or **▼** to select your desired language.

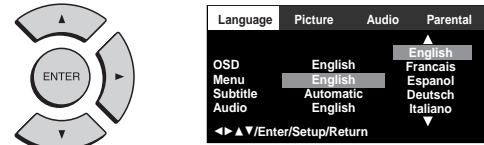

- 3 Press **ENTER**. The selected language remains.



- 4 Press **SETUP** or **RETURN** to close the screen.



If the unit does not operate properly:

Static electricity, etc., may affect the player's operation. Disconnect the AC mains lead once, then connect it again.

English, Francais, Espanol, Deutsch, Italiano, Portugues, Nederlands:

The selected language is the first-priority Menu language.

Other:

If you want to select another language, enter the language code with **number buttons (0-9)** (see the "Language code list" on page 24).



Setting Subtitle language

The same subtitle language can always be selected even if you replace the disc or turn the power off.

- 1 Press **SETUP** in the stop mode. Press **▼** or **ENTER**, then press **▲** or **▼** to select "Subtitle".

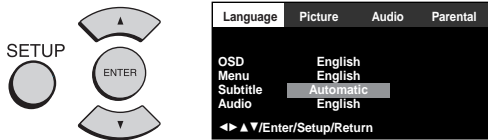

- 2 Press **▶** or **ENTER**, then press **▲** or **▼** to select your desired language.

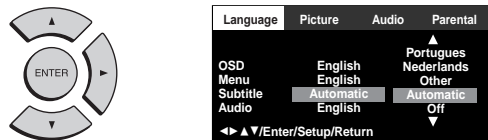

- 3 Press **ENTER**. The selected language remains.



- 4 Press **SETUP** or **RETURN** to close the screen.



English, Francais, Espanol, Deutsch, Italiano, Portugues, Nederlands:

The language you have selected will play if it is recorded on the disc.

Other:

If you want to select another language, enter the language code with **number buttons (0–9)**. (See the "Language code list" on page 24.)

Automatic:

- The unit will automatically select the same language in the "Audio" setting.
- When the unit selects the same language as the "Audio", the subtitles will not appear during play.
- When you do not use the same language as the "Audio", the subtitles will appear during play.

Off:

Subtitles do not appear.

Setting Audio soundtrack language

The same audio soundtrack language can always be selected by your unit even if you replace the disc or turn the power off.

- 1 Press **SETUP** in the stop mode. Press **▼** or **ENTER**, then press **▲** or **▼** to select "Audio".

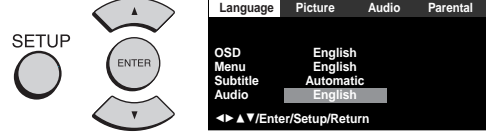

- 2 Press **▶** or **ENTER**, then press **▲** or **▼** to select your desired language.

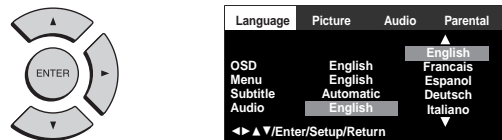

- 3 Press **ENTER**. The selected language remains.



- 4 Press **SETUP** or **RETURN** to close the screen.



English, Francais, Espanol, Deutsch, Italiano, Portugues, Nederlands:

The language you have selected will play if it is recorded on the disc.

Other:

If you want to select another language, enter the language code with **number buttons (0–9)**. (See the "Language code list" on page 24.)

Original:

The unit will select the first priority language of each disc.



Setting the aspect ratio of TV screen

You can select an aspect ratio appropriate to your TV.

- 1 Press **SETUP** in the stop mode. Press **◀** or **▶** to select "Picture", then press **▼** or **ENTER**.



- 2 Press **▲** or **▼** to select "Tv Screen".

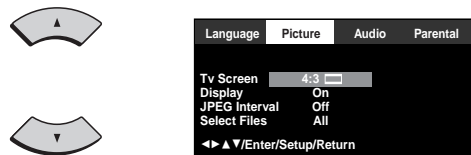

- 3 Press **▶** or **ENTER**, then press **▲** or **▼** to select your desired screen type.

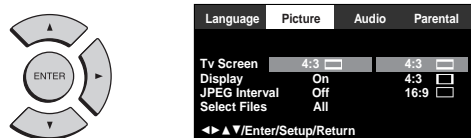

You have the following screen size to choose from:

4:3 : LETTERBOX

Select this mode when connecting to a conventional TV. When playing back a wide screen-DVD disc, it displays the wide picture with black bands at the top and bottom of screen.

4:3 : PAN SCAN (Conventional mode)

Displays the wide picture on the whole screen with left and right edges automatically cut off.

16:9 : WIDE SCREEN

Select this mode when connecting to a wide-screen TV. A wide screen picture is displayed full size.

- 4 Press **ENTER**.
The selected TV screen remains.



- 5 Press **SETUP** or **RETURN** to close the screen.

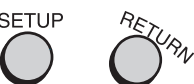

Note:

If the DVD disc is not formatted in the pan & scan style, it will display a letterboxed picture.

20

Setting on screen display

On screen display can be viewed when you press the operation buttons.

- 1 Press **SETUP** in the stop mode. Press **◀** or **▶** to select "Picture", then press **▼** or **ENTER**.



- 2 Press **▲** or **▼** to select "Display".

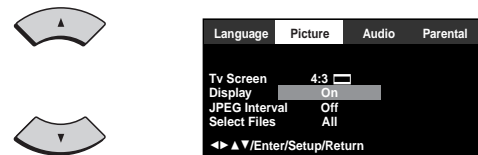

- 3 Press **◀** / **▶** or **ENTER** to select "On" or "Off".

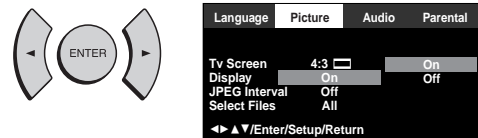

On: On screen displays appear when you press the operation buttons.

Off: On screen displays do not appear when operation buttons are pressed.

- 4 Press **SETUP** or **RETURN** to close the screen.





Setting JPEG Interval

You can continuously play back all JPEG files automatically.

After the setting below, start playing the disc on which JPEG files have been recorded.

- 1** Press **SETUP** in the stop mode. Press **◀** or **▶** to select "Picture", then press **▼** or **ENTER**.

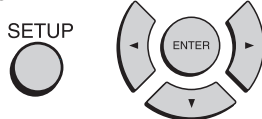

- 2** Press **▲** or **▼** or **ENTER** to select "JPEG Interval".

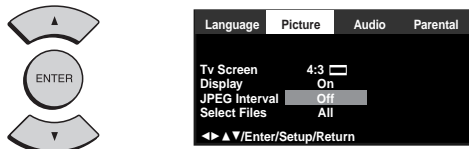

- 3** Press **▶** or **ENTER**, then press **▲** or **▼** to select your desired time.

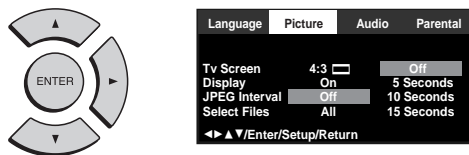

Off:

Plays back one file at a time.

5 Seconds:

Plays back images in the form of a slide show at 5-second intervals.

10 Seconds:

Plays back images in the form of a slide show at 10-second intervals.

15 Seconds:

Plays back images in the form of a slide show in 15-second intervals.

- 4** Press **ENTER**. The selected interval time remains.



- 5** Press **SETUP** or **RETURN** to close the screen.

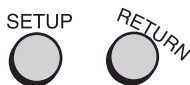

Setting Select Files

When playing back a CD containing a mixture of MP3, WMA and JPEG files, only MP3/WMA or JPEG files can be displayed on the file menu.

- 1** Press **SETUP** in the stop mode. Press **◀** or **▶** to select "Picture", then press **▼** or **ENTER**.

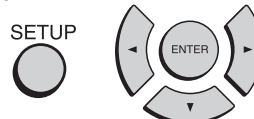

- 2** Press **▲** or **▼** or **ENTER** to select "Select Files".

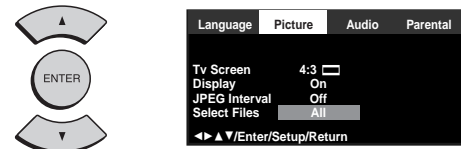

- 3** Press **▶** or **ENTER**, then press **▲** or **▼** to select your desired file type.

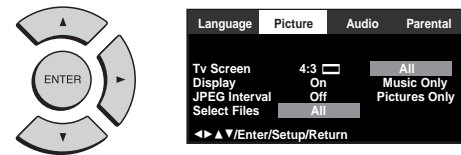

All:

Displays all files on the file menu.

Music Only:

Displays only MP3/WMA files on the file menu.

Pictures Only:

Displays only JPEG files.

- 4** Press **ENTER**. The selected file type remains.



- 5** Press **SETUP** or **RETURN** to close the screen.

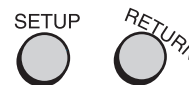



Dynamic Range Control (DRC)

DRC (Dynamic Range Control) enables you to control the dynamic range so as to achieve a suitable sound for your equipment.

- 1** Press **SETUP** in the stop mode. Press ◀ or ▶ to select "Audio", then press ▼ or **ENTER**.

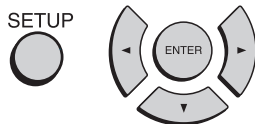

- 2** Press ▲ or ▼ to select "DRC".

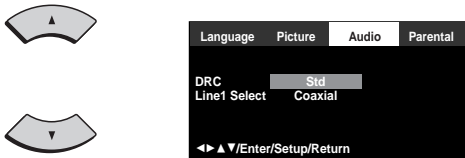

- 3** Press ▶ or **ENTER**, then press ▲ or ▼ to select your desired sound type.

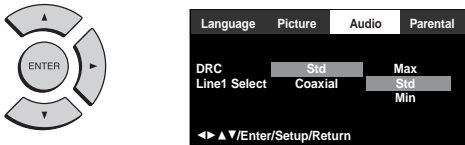

Max: Full dynamic range is increased.
Std: Full dynamic range is maintained.
Min: Dynamic range is reduced.

- 4** Press **ENTER**. The selected sound type remains.



- 5** Press **SETUP** or **RETURN** to close the screen.

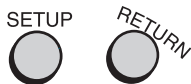

Line1 Select

If you connect another unit (DVD, VCR or etc.) to the LINE IN1 sockets, you must select the type of audio input.

- 1** Press **SETUP** in the stop mode. Press ◀ or ▶ to select "Audio", then press ▼ or **ENTER**.

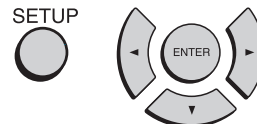

- 2** Press ▲ or ▼ to select "Line1 Select".

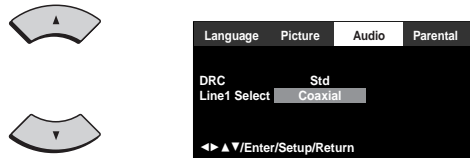

- 3** Press ▶ or **ENTER**, then press ▲ or ▼ to select the appropriate type of audio input.

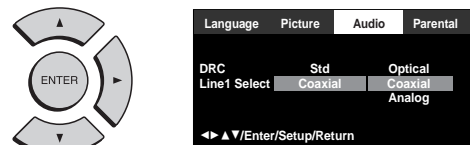

- 4** Press **ENTER**. The selected appropriate type remains.



- 5** Press **SETUP** or **RETURN** to close the screen.

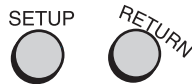

Notes:

- This function works only during playback of Dolby Digital recorded discs.
- The level of Dynamic Range Reduction may differ depending on DVD video disc.





Parental control setting

Some discs are specified as not suitable for children. Playback of such discs can be restricted with this unit.

- 1** Press **SETUP** in the stop mode. Press ◀ or ▶ to select "Parental", then press ▼ or **ENTER**.



- 2** Press ▲ or ▼ to select "Parental".

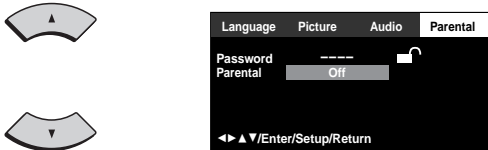

- 3** Press ◀ or ▶ until the level you require appears.

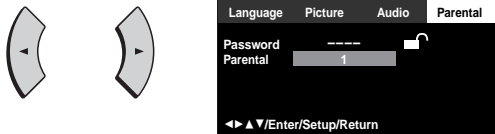

- **Level Off** : The parental control setting does not function.
- **Level 8** : Virtually all DVD software can be played back.
- **Level 1** : DVD software for adults cannot be played back.
- Select from level 1 to level 8. The limitation will be more severe as the level number decreases.

- 4** Press ▲ or ▼ to select "Password". Press **number buttons (0–9)** to input a 4-digit password. Be sure to remember this number!



- If you input a wrong number, press **CANCEL**.

- 5** Press **ENTER** to store the password.



Note: Now the rating is locked and the setting cannot be changed unless you enter the correct password.

- 6** Press **SETUP** or **RETURN** to close the screen.



To change the parental level

- 1** Select "Password" on step 2 as left, then input your password with **number buttons (0–9)**.

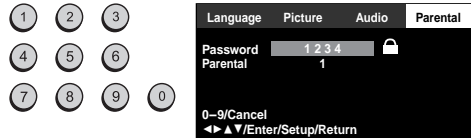

- 2** Press **ENTER**. The rating is now unlocked.

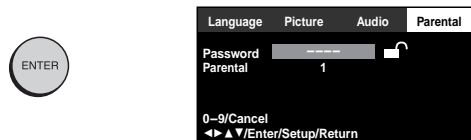

- 3** Press ▲ or ▼ to select "Parental", then press ◀ or ▶ to change the parental level.

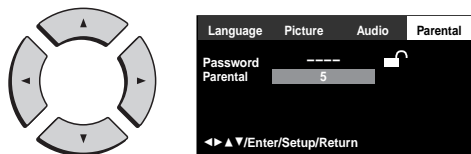

- 4** Press ▲ or ▼ to select "Password", then press **number buttons (0–9)** to enter the password.

Note: You can change the password at this time if you want.

- 5** Press **ENTER**. The parental level is changed and locked.



- 6** Press **SETUP** or **RETURN** to close the screen.

If you forget the password...

1. Press **OPEN/CLOSE** to open the disc tray.
2. Remove the disc.
3. Press **OPEN/CLOSE** again to close the disc tray. "No Disc" appears on the screen.
4. While holding **STOP** down on the front panel, press **7** on the remote control. "PASSWORD CLEAR" appears on the screen.
5. Enter a new password again.

Notes:

- Depending on the discs, the unit may not be able to limit playback.
- Some discs may not be encoded with specific rating level information though its disc jacket says "adult." For those discs, the parental control feature will not work.





Language code list

Enter the appropriate code number for the initial settings "Menu", "Subtitle" and "Audio" language on page 18 and 19.

Language Name	Code	Language Name	Code	Language Name	Code	Language Name	Code
Abkhazian	1112	Fiji	1620	Lingala	2224	Singhalese	2919
Afar	1111	Finnish	1619	Lithuanian	2230	Slovak	2921
Afrikaans	1116	French	1628	Macedonian	2321	Slovenian	2922
Albanian	2927	Frisian	1635	Malagasy	2317	Somali	2925
Amharic	1123	Galician	1722	Malay	2329	Spanish	1529
Arabic	1128	Georgian	2111	Malayalam	2322	Sundanese	2931
Armenian	1835	German	1415	Maltese	2330	Swahili	2933
Assamese	1129	Greek	1522	Maori	2319	Swedish	2932
Aymara	1135	Greenlandic	2122	Marathi	2328	Tagalog	3022
Azerbaijani	1136	Guarani	1724	Moldavian	2325	Tajik	3017
Bashkir	1211	Gujarati	1731	Mongolian	2324	Tamil	3011
Basque	1531	Hausa	1811	Nauru	2411	Tatar	3030
Bengali; Bangla	1224	Hebrew	1933	Nepali	2415	Telugu	3015
Bhutani	1436	Hindi	1819	Norwegian	2425	Thai	3018
Bihari	1218	Hungarian	1831	Oriya	2528	Tibetan	1225
Breton	1228	Icelandic	1929	Panjabi	2611	Tigrinya	3019
Bulgarian	1217	Indonesian	1924	Pashto, Pushto	2629	Tonga	3025
Burmese	2335	Interlingua	1911	Persian	1611	Turkish	3028
Byelorussian	1215	Irish	1711	Polish	2622	Turkmen	3021
Cambodian	2123	Italian	1930	Portuguese	2630	Twi	3033
Catalan	1311	Japanese	2011	Quechua	2731	Ukrainian	3121
Chinese	3618	Javanese	2033	Rhaeto-Romance	2823	Urdu	3128
Corsican	1325	Kannada	2124	Romanian	2825	Uzbek	3136
Croatian	1828	Kashmiri	2129	Russian	2831	Vietnamese	3219
Czech	1329	Kazakh	2121	Samoan	2923	Volapük	3225
Danish	1411	Kirghiz	2135	Sanskrit	2911	Welsh	1335
Dutch	2422	Korean	2125	Scots Gaelic	1714	Wolof	3325
English	1524	Kurdish	2131	Serbian	2928	Xhosa	3418
Esperanto	1525	Laothian	2225	Serbo-Croatian	2918	Yiddish	2019
Estonian	1530	Latin	2211	Shona	2924	Yoruba	3525
Faroese	1625	Latvian, Lettish	2232	Sindhi	2914	Zulu	3631





Playback procedure

Basic playback

Preparation:

- Turn ON the TV and select to the corresponding video input.

1 Press **I/⏻** (**ON/STANDBY**).
(If the unit is in FM/AM mode, press **DVD/FM/AM** to select DVD mode.)
“Reading” display will change to “No Disc”.
(If DVD disc has already loaded, playback will start automatically.)

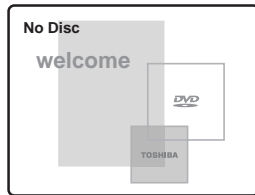

2 Press **OPEN/CLOSE**.
The disc tray will open.



3 Place a disc onto the disc tray.
Hold the disc, position it with the printed label side up, align it with the guides, and place it in its proper position.

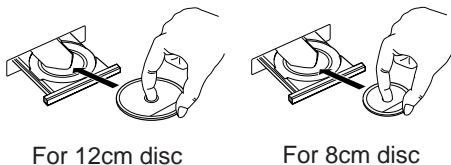

4 Press **PLAY** or **OPEN/CLOSE**.
The disc tray closes automatically.
On the screen display, “▲” changes to “Reading” and then playback commences.



- A menu screen will appear on the TV screen, if the disc has a menu feature. Press **▲/▼** or **◀/▶** to select desired title, then press **ENTER** or **PLAY**. The title is selected and play commences.

5 Adjust the volume by rotating **Volume knob** on the front panel or **VOL +/-** on the remote control.



6 Press **STOP** to end playback.



■ Resuming facility

- The unit memorizes the stop location, “▶” appears on the screen. Press **PLAY** to resume playback (from the stopped location).
- If you press **STOP** again or unload the disc (“■” appears on the screen.), the unit will clear the stopped location from its memory.

7 To stop playback, press **STOP**. Then press **OPEN/CLOSE**.
The disc tray opens.
Remove the disc then press **I/⏻** (**ON/STANDBY**).
The disc tray closes automatically and unit turns off.



Notes:

- If a non-compatible disc is loaded, “Incorrect Disc”, “Region Code Error” or “Parental Error” will appear on the screen according to the type of loaded disc. In this case, check your disc again (see pages 6 and 23).
- Some discs may take a minute or so to start playback.
- When you insert a disc with the label facing downwards (ie. the wrong way up) and press **PLAY** or **OPEN/CLOSE** on the unit, “Reading” will appear on the display and then “Incorrect Disc” will be displayed.
- Some discs may not work the resuming facility.
- Resuming cannot function when you play a PBC-featured Video CD while the PBC is on. To turn off the PBC, see page 31.
- Some playback functions of DVDs may be intentionally fixed by software producers. This unit plays DVDs in accordance with the design intent of the software producers. Some playback features may not be available. Also refer to the instructions supplied with the DVD.



Special playback

Note: There may be a slight delay between you pressing the button and the function activating.

Fast forward playback

Press **SEARCH +** during normal playback. Each press of **SEARCH +** will increase the speed of the search **▶▶, ▶▶▶, ▶▶▶▶, ▶▶▶▶▶**.

SEARCH
TUNE +



Review playback

Press **SEARCH -** during normal playback. Each press of **SEARCH -** will increase the speed of the search **◀◀, ◀◀◀, ◀◀◀◀, ◀◀◀◀◀**.

- SEARCH
TUNE



Still playback

Press **PAUSE/STEP** during normal playback to pause playback.

PAUSE/STEP



Frame advance

Press **PAUSE/STEP** during still playback. One frame is advanced each time you press **PAUSE/STEP**.

PAUSE/STEP



Slow-motion playback

Press **SLOW -** Reverse or **SLOW +** Forward during normal playback or still playback. Each press of **SLOW +** or **-** will change the speed of the slow x1/2, x1/4, x1/6, x1/7.

- SLOW +



■ To resume normal playback. Press **PLAY**.

PLAY



Note:

- The VIDEO CD can not play Reverse Slow.
- To resume normal playback, press **PLAY**.
- To resume the still playback, press **PAUSE/STEP**.

Locating a chapter or track

Press **SKIP +** Forward or **SKIP -** Reverse during playback to locate a chapter or track that you want to watch.

- SKIP
PRESET +



- Press **SKIP +** briefly to select the next chapter/track.
- Press **SKIP -** briefly to return to the beginning of the current chapter/track.
- Press **SKIP -** twice in quick successions to select the previous chapter/track.

Picture zoom

This unit will allow you to zoom in on an image. You can then make selections by switching the position of the zoom point on the frame.

- 1 Press **ZOOM** during playback. The centre part of the image will be zoomed in.



Each press of **ZOOM** will change the ZOOM as follows.

DVD	Q1 (x 1.3)	Q2 (x 1.5)	Q3 (x 2.0)
Video CD	Q1 (x 1.3)	Q2 (x 1.5)	-

- 2 Press **▲/▼/◀/▶** to view a different part of the frame.

You may move the frame from the centre position to UP, DOWN, LEFT or RIGHT direction.

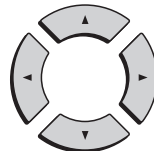

- 3 In the zoom mode press **ZOOM** repeatedly to return to a 1:1 view (Q Off).



Notes:

- You can select Pause, Slow or Search playback from the zoom mode.
- Some discs may not respond to the zoom feature.



Marking the scenes

The unit stores the points that you want to watch again up to 3 points. You can resume playback from each scene.

1 Press **MARKER** during playback.



Marker 1 :	***:***:***
Marker 2 :	***:***:***
Marker 3 :	***:***:***
▲▼/Enter/Cancel/Marker	

2 Select the blank Marker using ▲/▼. Then press **ENTER** at the desired scene.

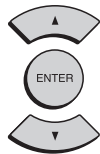

Marker 1 :	00 : 27 : 54
Marker 2 :	***:***:***
Marker 3 :	***:***:***
▲▼/Enter/Cancel/Marker	

- Repeat this procedure to set the other 2 scenes.

3 Press **MARKER** to remove this display.



Notes:

- Some discs may not work with the marking operation.
- The marking is cancelled when you open the disc tray or turn the power off.
- Some subtitles recorded around the marker may fail to appear.

Returning to the scenes

1 Press **MARKER** during playback or stop mode.



Marker 1 :	***:***:***
Marker 2 :	***:***:***
Marker 3 :	***:***:***
▲▼/Enter/Cancel/Marker	

2 Press ▲/▼ to select the Marker 1 ~ 3.



Marker 1 :	00 : 27 : 54
Marker 2 :	01 : 16 : 25
Marker 3 :	02 : 08 : 31
▲▼/Enter/Cancel/Marker	

3 Press **ENTER**. Playback starts from the marked scene.



■ To cancel the mark

Press **CANCEL** in step 2.

- To remove this display, press **MARKER**.

Locating desired scene

Use the title, chapter and time recorded on the disc to locate the desired playback point.

1 Press **JUMP** during playback.



Jump Time :	---:---:---
Title :	---
Chapter :	---
▲▼/Enter/0-9/Cancel/Jump	

2 Press ▲ or ▼ to select the "Time", "Title" or "Chapter".



Jump Time :	---:---:---
Title :	---
Chapter :	---
▲▼/Enter/0-9/Cancel/Jump	

3 Press **number buttons (0-9)** to change the number.

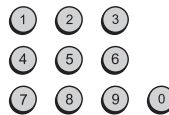

Jump Time :	---:---:---
Title :	---
Chapter :	12-
▲▼/Enter/0-9/Cancel/Jump	

- If you input a wrong number, press **CANCEL**.
- Refer to the package supplied with the disc to check the numbers.

4 Press **ENTER**. Playback starts.



- When you change the title, playback starts from Chapter 1 of the selected title.
- Some discs may not be compatible with the above operation.



Title, Chapter and Track Repeat playback

Press **PLAYMODE** during playback or stop mode.



DVD

Press **◀/▶** or **ENTER** once or twice to select "Chapter" or "Title".

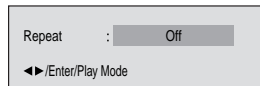
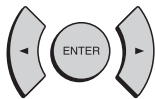

Audio CD, Video CD, MP3/WMA CD

Press **▼** to select "Repeat".

Press **◀/▶** or **ENTER** once or twice to select "Track" or "All".

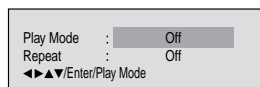
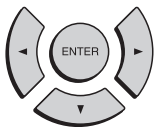

Press **PLAY** to start Repeat playback.



- To resume normal playback, select Repeat "Off".

Notes:

- In case of Video CD, repeat functions are prohibited during playback.
- Some discs may not be compatible with the repeat operation.

A-B Repeat playback

A-B repeat playback allows you to repeat material between two selected points.

- 1 Press **A-B RPT** during playback. The start point is selected.

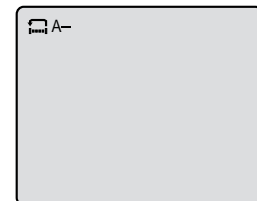

- 2 Press **A-B RPT** again. The end point is selected. Playback starts at the point that you selected. Playback stops at the end point, and resumes again at point A.

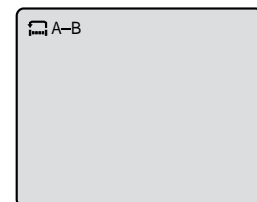

- To resume normal playback press **A-B RPT** again. "Off" appears on the screen.

Notes:

- In A-B Repeat mode, subtitles near the A or B locations may not be displayed.
- You can not set the A-B Repeat for the scenes that include multiple angles.
- You may not be able to set A-B Repeat, during certain scenes of the DVD.
- A-B Repeat does not work with an interactive DVD, MP3/WMA/JPEG CD.
- A-B Repeat is prohibited when PBC is on.





Programme playback

You can arrange the playback order of tracks on the disc.

- 1** Press **PLAYMODE** in the stop mode.



- 2** Press **▲/▼** to select "Play Mode", then press **◀/▶** or **ENTER** to select "Program".



Play Mode	: Program
Repeat	: Off
1	4 7 10
2	5 8 11
3	6 9 12
Clear	Program Playback
◀▶▲▼/Enter/0-9/Cancel/Play Mode	

- 3** Press **▲/▼** or **◀/▶** to select the programming position. Use **number buttons (0-9)** to input the Track numbers.

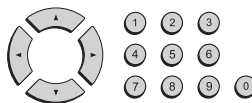

Play Mode	: Program
Repeat	: Off
1	9 4 7 10
2	3 5 8 11
3	1 6 9 12
Clear	Program Playback
◀▶▲▼/Enter/0-9/Cancel/Play Mode	

- To programme others, repeat step 3.
- If you input a wrong number, press **CANCEL**.

- 4** Press **▲/▼** or **◀/▶** to select "Program Playback" and press **ENTER**. The programmes in the order you selected will start playback. To return to normal playback, select Play Mode: "Off".



■ To change the programme

1. In the programme mode, press **▲**, **▼**, **◀** or **▶** to select the track number.
2. Press **number buttons (0-9)** to select the track number to be replaced.

■ To clear the programme one by one

In the programme mode, press **▲**, **▼**, **◀** or **▶** to select the track number. Then press **CANCEL**.

■ To clear all the programmes

In the programme mode, press **▲**, **▼**, **◀** or **▶** to select "Clear". Then press **ENTER**.

Note:

The programme is cancelled when you open the disc tray or turn the power off.

Random playback

- 1** Press **PLAYMODE** in the stop mode.



- 2** Press **▲/▼** to select "Play Mode", then press **◀/▶** or **ENTER** to select "Random".



Play Mode	: Random
Repeat	: Off
◀▶▲▼/Enter/Play Mode	

- 3** Press **PLAY**. Random playback will start.
- To cancel Random playback, select "Off" in step 2.



Changing angles

When playing back a disc recorded with multiple camera angles, you can change the angle that you are viewing.

- 1** Press **ANGLE** during playback. The current angle will appear.

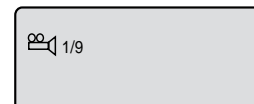

- 2** Press **ANGLE** repeatedly until the desired angle is selected.





Note:

Depending on the DVD, you may not be able to change the angles even if multi-angles are recorded on the DVD.



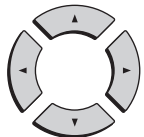

Title selection

Two or more titles may be recorded on some discs. If a title menu is recorded on the disc, you can select the desired title.

- 1 Press **TOP MENU** during playback.
Title menu appears on the screen.

- 2 Press **▲/▼** or **◀/▶** to select the desired title.

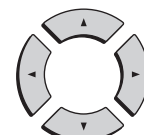
- 3 Press **ENTER** or **PLAY**.
The playback of the selected title will start.
 

DVD menu



Some DVDs allow you to select the disc contents via the disc menu. When you play back these DVDs, you can select the subtitle language and sound-track language, etc. from the MENU.



- 1 Press **MENU** during playback.
The DVD menu appears on the screen.

 - Press **MENU** again to resume playback at the scene when you pressed **MENU**.
- 2 Press **▲/▼** or **◀/▶** to select the desired item.

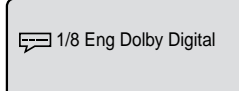
- 3 Press **ENTER**.
The menu continues to another screen.
Repeat steps 2 and 3 to set the item completely.

Note:
Depending on the DVD, you may not be able to select the title. On some DVD's a "title menu" may simply be called a "menu" or "top menu" in the instructions supplied with the disc.

Changing soundtrack language

You can select a desired language from a multilingual disc.

- 1 Press **AUDIO** during playback.
The current soundtrack language will appear.
 
- 2 Press **AUDIO** repeatedly until the desired language is selected.



■ **In case of VIDEO CD playback**
Audio type changes as follows each time you press **AUDIO**.
 LR →  L →  R

Notes:

- If the desired language is not heard after pressing the button several times, the soundtrack language is not recorded on the disc.
- A selected soundtrack language may be cancelled when you open the disc tray.
The initial default language or available language will be heard if the disc is played back again.

Subtitles

When playing back a disc recorded with subtitles, you can select the subtitle language or turn the subtitle off.

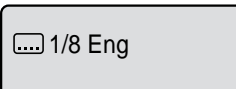
- 1 Press **SUBTITLE** repeatedly during playback until your desired language appears.
 
 - To turn off the subtitle, press **SUBTITLE** until "Off" appearst.
- 2 The on-screen display will disappear after a few seconds.

Notes:

- Depending on the DVD, you may not be able to change subtitles, or to turn subtitles on or off.
- While playing a DVD, the subtitle may change when you open or close the disc tray.
- In some cases, a selected subtitle language may not be changed immediately.



Disc Status

With each press of **DISPLAY**, the status of the disc will appear on the screen and change as follows.

DISPLAY



DVD

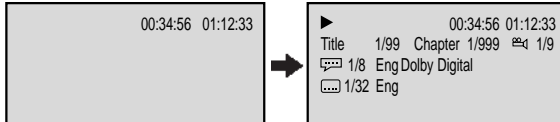

To make status display disappear, press **DISPLAY** again.

VIDEO CD



To make status display disappear, press **DISPLAY** again.

AUDIO CD

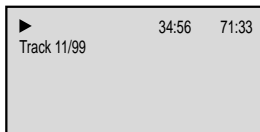

When you playback the CD disc, the status display will appear on the screen and continue displaying.

To turn off the PBC

Press **number button 1** in the stop mode, then press **ENTER**.





MP3/WMA/JPEG CD OPERATION

This player can play back the MP3/WMA/JPEG-data which has been recorded on CD-R or CD-RW. To produce the MP3/WMA/JPEG-data, you need a Windows-PC with CD-ROM drive and a MP3/WMA/JPEG-encoding Software (not supplied). The Apple-HFS-System can not be played.

MP3/WMA/JPEG CD information

Limitations on MP3/WMA/JPEG CD playback

- MP3/WMA/JPEG CD is the disc that is standardized by ISO9660, its file name must include 3-digits extension letters, "mp3", "wma", "jpg".
- MP3/WMA/JPEG CD must be correspond to the ISO standardized files.
- This unit can read 200 files per disc. If one directory has more than 200 files, it reads up to 200 files, the remaining files will be omitted.
- The unit is able to recognize up to a maximum of 50 directories per disc.
- MP3/WMA/JPEG CDs cannot be used for playback for the purpose of recording.
- If the CD has both audio tracks and MP3/WMA/JPEG files, only audio tracks are played.
- It may take more than one minute for this unit to read MP3/WMA/JPEG files depending on its structure.
- Music recorded by "Joliet Recording Specification" can be played back, the file name is displayed (within 16 letters) on the screen. Long file names will be condensed.
- The music files recorded by "Hierarchical File System" (HFS) cannot be played.

Limitations on display

- The maximum number for display is 16 letters.
Available letters for display are the following:
capital or small alphabets of A through Z, numbers of 0 through 9, and _ (under score).
- Other letters than those above are replaced in hyphen.

Notes on MP3/WMA/JPEG files

To play back MP3/WMA/JPEG CD in the recorded order,

1. Use MP3/WMA/JPEG software that records data alphabetically or numerically.
2. Name each file including two-digit or three-digit number (e.g. "01" "02" or "001" "002").
3. Refrain from making too many sub-folders.

CAUTION:

- Some MP3/WMA/JPEG CDs can not be played back depending on the recording conditions.
- The CD-R/RW that has no music data or non MP3/WMA/JPEG files can not be played back.

Standard, sampling frequency, and the bit rate:

MP3 CD

MPEG-1 Audio

32kHz, 44.1kHz, 48kHz

32kbps ~ 320kbps (constant bit rate or variable bit rate)

The recommend recording setting for a high-quality sound is 44.1kHz of sampling frequency and 128kbps of constant bit rate.

WMA CD

WMA version 7, and 8

32kHz, 48kbps

44.1kHz, 48kbps ~ 192kbps

48kHz, 128kbps ~ 192kbps

The file recorded by mono, 48kHz, 48 kbps is not available to this unit.



MP3/WMA CD playback

1 Place a disc on which MP3 or WMA files have been recorded onto the disc tray.

2 A file menu screen will appear on the screen. Press **◀/▶** or **ENTER** to select folder.

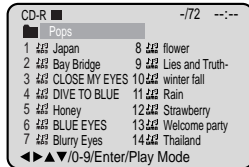
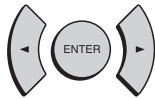

3 Press **▲/▼** or **◀/▶** or **number buttons (0-9)** to select the desired file.

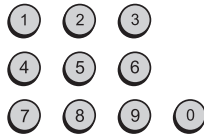
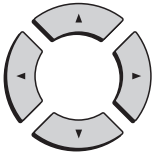

• In case the folder includes more than 15 files, press **◀** or **▶** to display next file list.

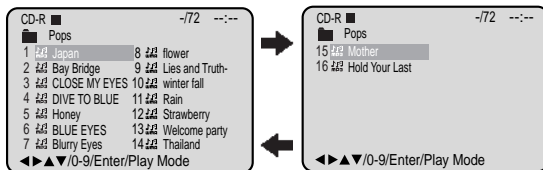

• When **PLAY** has been pressed after displaying the file menu, or when the disc tray has been closed using **PLAY**, playback begins automatically starting from the first file. In this case, if the first file is an MP3/WMA file, only MP3/WMA files are played back in order. If the first file is a JPEG file, the first JPEG file is played back.

4 Press **ENTER**. The selected file starts playing back.



5 Press **STOP** to end playback.



- The unit records the stopped point. “■” appears on the screen. Press **PLAY** to resume playback (from the scene point).
- If you press **STOP** again or unload the disc, the unit will clear the stopped point.

About file menu

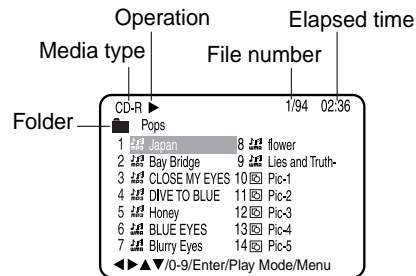

: Indicates MP3-file



: Indicates WMA-file



: Indicates JPEG-file

Notes:

- The picture menu is displayed when the FUJICOLOR CD or the Kodak Picture CD are played. To display the file menu press **TOP MENU**.
- In the case of a CD containing a mixture of MP3, WMA and JPEG files, the files are played back by selecting them from the file menu.
- MP3 or WMA file on the KODAK Picture CD is not recognized on this unit.

Notes:

- During MP3/WMA/JPEG-Playback, you can not use **SEARCH**, **A-B Repeat** functions.
- You can use **Repeat (Track or All)**, **Random** functions and **Programme playback** for MP3/WMA/JPEG CD Playback (see pages 28 and 29).
- In the case of a CD containing a mixture of MP3, WMA and JPEG files, the files are played back by selecting them from the file menu.



JPEG CD playback

1 Place a disc on which JPEG files have been recorded onto the tray.

2 A file menu screen will appear on the screen. Press **◀/▶** to select folder.

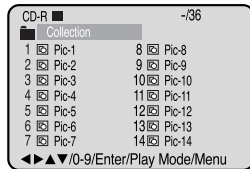

3 Press **▲/▼** or **◀/▶** or **number buttons (0-9)** to select the desired file. To display a picture menu, press **MENU**. (To return to a file menu, press **TOP MENU**.) Press **▲/▼** or **◀/▶** to select the desired file.

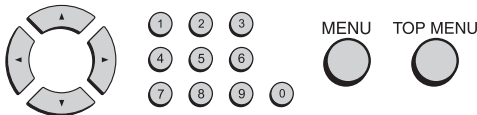

- To display next list, press **SKIP +/-**.
- When **PLAY** has been pressed after displaying the file menu, or when the disc tray has been closed after pressing **PLAY**, playback begins automatically starting from the first file. In this case, if the first file is a JPEG file, the first JPEG file is played back. If the first file is an MP3/WMA file, only MP3/WMA files are played back in order.

4 Press **ENTER**. The selected picture appears on the screen.

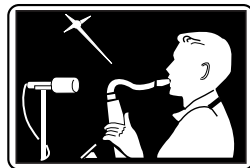

Rotating an image

You can rotate an image by 90 degrees by pressing **ANGLE** during playback of the image. “”, “”, “” or “” appears briefly on the screen.

5 Press **STOP** to end playback. The file menu appears on the screen. If you want to watch the other file, repeat steps 3 ~ 4.



Slide show playback

The slide show enables you to view pictures (files) one after another automatically.

Preparation:

- Set “JPEG Interval” setting to “5 Seconds”, “10 Seconds” or “15 Seconds” (see page 21).

1 Select your desired starting file for the slide show in the step 3 as left.

2 Press **ENTER** to start slide show from the selected file.



- If you press **PAUSE** during the slide show, the slide show stops temporary. “” appears briefly on the picture. If the picture appears upside down or sideways, press **ANGLE** repeatedly until it's right side up. “”, “”, “” or “” appears briefly on the screen. Press **PLAY** or **SKIP +** again to resume the slide show.
- When the slide show playback finished the file list appears.
- To stop the slide show, press **STOP**. The file list appears.





Progressive scan

The progressive scan capability provides the highest resolution pictures with less flicker and line structure. If you are using the Component video sockets, but are connecting the unit to a standard (analog) television, set PROGRESSIVE to Off.

If you are using the Component video sockets for connection to a TV or monitor that is compatible with a progressive scan signal, set PROGRESSIVE to On.

Note: This unit supports the progressive scan only for NTSC DVDs.

Selecting progressive scan

Preparation:

- Connect to a TV equipped with component sockets.
- Turn ON the TV and set it to the corresponding video input mode.
- Set the VIDEO OUTPUT selector switch on the rear panel to COMPONENT position.
- Press **DVD/FM/AM** selector to select the DVD mode.

1 Load an NTSC DVD disc.
Press **PROGRESSIVE** in the stop mode.
The current progressive mode appears on the display window for 4 seconds.
Press **PROGRESSIVE** again to change the progressive mode "ON" or "OFF" during the progressive mode appears on the display window.

PROGRESSIVE



- The unit recognizes the picture source (film or video) of the current disc according to the disc information.

2 Press **PLAY** to start playback.

PLAY



■ To select PROGRESSIVE scan Off

On the step 1 above, select "PRO. OFF".

Notes:

- JPEG CDs can not be play back with the progressive scanning mode.
- Some discs may not be played back with the progressive scanning mode correctly because of the disc characteristics or recording condition.
- If your TV does not accept the progressive scan format, the picture will appear scrambled if you select progressive scan output from the unit. In such a case, select PROGRESSIVE scan Off.

There are two types of source content in pictures recorded in DVD video discs: film content (pictures recorded from films at 24 frames per second) and video content (video signals recorded at 30 frames per second).

When the unit plays back a film source material, uninterlaced

progressive output signals are created using the original information. When a video content is played back, the unit interleaves lines between the interlaced lines on each to create the interpolated picture and outputs as the progressive signal.



Radio operation

Tuning the radio stations

- 1 Press **DVD/FM/AM** to select FM or AM. "TUNER FM" or "TUNER AM" appears on the window display for 3 seconds and changes to radio operation mode.



- 2 **Automatic tuning**
Press and hold **TUNE +** or **-** for 1 second to start the automatic tuning. The scanning stops when the unit tunes in a station. Press the button again to tune the other stations.

Manual tuning

Press **TUNE +** or **-** briefly to tune in a station. The frequency changes in 50 kHz steps for FM and 9 kHz steps for AM.



Presetting the radio stations

You can preset 30 stations for FM and AM.

Automatic presetting

1. Press **DVD/FM/AM** to select FM or AM.



2. Press **SETUP** for 2 seconds. "A. PRESET" appears on the window display, then starts the automatic presetting from the low end of FM band to the AM band.



After all FM and AM stations have been preset, automatic presetting stops and the station memorized position 1 will be listened.

Manual presetting

1. Tune the station to be preset as described in "Automatic/Manual tuning".
2. Press **SETUP**. "M. PRESET" appears on the window display, then the preset position number blinks.



3. Press **PRESET +** or **-** to select the position number to be preset.



4. Press **ENTER**. The preset position number stops blinking and now the station is preset in the memory.



5. Press **SETUP**. The preset position number disappears.



6. For presetting of other stations, repeat steps 1 ~ 5 above.



Listening to the radio

Preset the radio stations first as described on page 36.

- 1** Press **DVD/FM/AM** to select FM or AM.



- 2** Press **PRESET +** or **-** to select the desired position number.



You can also select the desired position number using the **number buttons (0-9)**, then press **ENTER**.

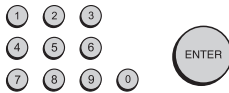

- For example, to select the preset position number 7, press **0** and **7**, then press **ENTER**. To select the preset position number 25, press **2** and **5**, then press **ENTER**.

- 3** Adjust the volume by rotating **Volume knob** on the front panel or **VOL +/-** on the remote control.



Reception of RDS (Radio Data System) stations

RDS (Radio Data System) is a system gradually being introduced on FM in many countries, where by an inaudible stream of data is transmitted in addition to the normal radio signal. This data contains various information including station/transmitter identification, traffic information and a list of alternative frequencies for the radio station being received.

- 1** Press **DVD/FM/AM** select FM.



- 2** Select a desired station by pressing the **PRESET +** or **-**. When the RDS transmission is received, the RDS indicator and the programme service name (PS) appear on the display window.



Notes:

- RDS is only available for FM reception.
- The PS (PROGRAM SERVICE) NAME is displayed automatically when a RDS station is received.



Other functions

Sleep timer

You can set the DVD receiver to turn off automatically at a specified time.
Press **SLEEP** to set the desired sleep time.
The SLEEP indicator and sleep time appears on the display window.



Each time you press **SLEEP**, the setting changes in the following order.

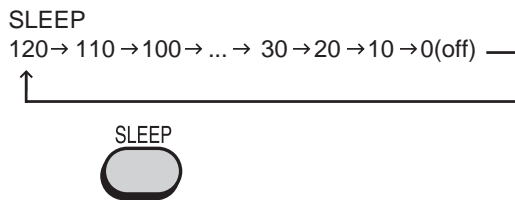

Notes:

- After the sleep timer is programmed, the remaining timer appears briefly every ten minutes on the display window.
- To confirm the sleep timer setting, press **SLEEP**.
- The remaining time appears on the display window.

Dimmer

This function will change the brightness of the display window and the control buttons on the front panel during Power-on status.
Press the **DIMMER** to dim the display window.
To cancel the Dimmer function, press **DIMMER** again.
Press and hold **DIMMER** for 3 seconds to dim the control buttons.
To cancel the Dimmer function, press and hold **DIMMER** for 3 seconds again.



Mute

Press **MUTE** to mute your unit.
You can mute your unit in order, for example, to answer the telephone, "MUTE" indicator appears on the display window.



Using headphone socket

Connect a stereo headphone plug (ø 3.5mm) into the HEADPHONE socket on the front panel.
The speakers are automatically disconnected when you plug in the headphones (not supplied).

Note:

When you use the headphones, keep the volume at a moderate level. If you use the headphones continuously with high volume sound, it may cause hearing damage.

Selecting input source

You can use VCRs or other units connected to the LINE IN 1 or LINE IN 2 connectors.
Press **INPUT SELECT** repeatedly on the remote control to select the desired input source.



Note:

The Optical/Coaxial input function is available only when the other unit's Sampling Frequency is as follows.
PCM: 32KHz, 44.1KHz, 48KHz
Dolby Digital: 48KHz
DTS: 44.1KHz, 48KHz
Depending on the setting or the combination of the other unit, the sound may not be played correctly.

Screen saver

The screen saver operates when you leave the unit in DVD stop mode for about five minutes.





Before calling service personnel

Check the following guide for the possible cause of a problem before contacting service.

Symptom	Cause	Correction	Page
No power.	The mains lead is disconnected.	Connect the mains lead securely into the wall outlet.	–
No picture.	The TV is not set to receive DVD signal output.	Select the appropriate video input mode on the TV so the picture from the unit appears on the TV screen.	12
	The scart or video lead is not connected securely.	Connect the scart or video lead securely into the appropriate socket.	12,13
	The operation mode is not correct.	Select the correct operating mode.	25,36
	The VIDEO OUTPUT selector is not set correctly.	Set the VIDEO OUTPUT selector to the appropriate position.	12
	The INPUT SELECT is not set correctly.	Set the INPUT SELECT to the appropriate position.	38
No sound.	The scart or audio lead is not connected securely.	Connect the scart or audio lead securely into the appropriate sockets.	12,13
	The unit is in the special playback mode.	Resume the normal playback.	26
	The operation mode is not correct.	Select the correct operating mode.	25,36
	The speaker connections are not set correctly.	Connect the speaker lead or wires correctly.	14
	The volume is set to minimum.	Adjust the volume level.	25
The playback picture has occasional distortion.	The disc is dirty.	Eject the disc and clean it.	5
	It is in fast forward or fast reverse playback.	Sometimes a small amount of picture distortion may appear. This is not a malfunction.	–
The DVD video player does not start playback.	No disc is inserted.	Insert a disc.	25
	An unplayable disc is inserted.	Insert a playable disc. (Check the disc type and colour system.)	6
	The disc is placed upside down.	Place the disc with the playback side down.	25
	The disc is not placed within the guide.	Place the disc correctly inside the guide on the disc tray.	25
	The disc is dirty.	Eject the disc and clean it.	5
	The parental lock function is set.	Cancel the parental lock function or change the parental lock level.	23
	⚡ appears on the screen.	The function is prohibited with the unit or the disc.	6
Playback does not follow the course of the disc's programme.	It is in the mode of repeat playback, programme playback, etc.	These operations may prevent a proper progress of the contents.	–
Buttons do not work.	Power supply fluctuations or other abnormalities such as static electricity may interrupt correct operations.	Turn the power on or off with ON/STANDBY. Or disconnect the power plug and insert it into the wall outlet again.	–
The remote control does not work properly.	The remote control is not pointed at the remote sensor of the unit.	Point the remote control at the remote sensor of the unit.	11
	The remote control is too far from the unit.	Operate the remote control within about 7 m.	11
	The batteries in the remote control are exhausted.	Replace the batteries with new ones.	11

Contact for technical assistance

If you are still having problem, please contact the Toshiba helpline on 0115 976 6958.





Specifications

General

Power supply	230 V~AC 50 Hz
Power consumption	Operation: 20 W, Stand by: 4 W
Weight	3.5 kg
Dimensions	Width: 430 mm, Height: 61.5 mm, Depth: 290 mm
Tuner	FM (STEREO), AM (MONO) FM 87.5~108.0 MHz, AM 522~1611 KHz
RF channel output	Channel 3 or 4, Switchable
Colour system	PAL, NTSC
Applicable disc	DVD (12 cm, 8 cm), CD (12 cm, 8 cm)
Frequency range	DVD: 4 Hz-22 kHz, CD: 4 Hz-20 kHz
S/N ratio	90dB
Harmonic distortion	0.3%
Wow and flutter	Less than 0.01% Wrms
Operating conditions	Temperature: 5°C-40°C, Operating status: Horizontal

Input/Output

Video input	1.0 V (p-p), 75 Ω, negative sync., phono socket x 2
Video output	1.0 V (p-p), 75 Ω, negative sync., phono socket x 1
Audio input	-8 dBm, 50 kΩ, negative sync., phono socket (L/R) x 2
Audio output	-8 dBm, 1 kΩ, negative sync., phono socket (L/R) x 1
S-video output	(Y) 1.0 V (p-p), 75 Ω, negative sync., Mini DIN 4-pin x 1 (C) 0.286 V (p-p), 75 Ω
Component video output	(Y) 1.0 V (p-p), 75 Ω, negative sync., phono socket x 1 (P _B)/(P _R) 0.7 V (p-p), 75 Ω, phono socket x 2
Audio input (BITSTREAM/PCM COAXIAL)	0.5 V (p-p), 75 Ω, phono socket x 1
Audio input (BITSTREAM/PCM OPTICAL)	Optical connector x 1
Audio output (6-Channel)	DIN 9-pin x 1

Speakers

Dimensions/Weight	Satellite: 110mm (W) 115mm (H) 69mm (D)/0.525kg Centre: 206 mm (W) 110 mm (H) 100 mm (D)/1.07kg Subwoofer: 210 mm (W) 348 mm (H) 225 mm (D)/5.81kg
Amplifier power	Front: 25 W + 25 W (3 Ω less than 0.1% distortion) Centre: 30 W (2.3 Ω less than 0.1% distortion) Surround: 25 W + 25 W (3 Ω less than 0.1% distortion) Subwoofer: 33 W (2.2 Ω less than 0.1% distortion)
Impedance	Centre: 2.3 Ω, Front/Surround: 3 Ω, Subwoofer: 2.2 Ω
Power requirements	230V~AC 50Hz, 60W

Supplied accessories

Audio/Video lead	1	Speakers	6
S-Video lead	1	Subwoofer lead	1
Scart lead	1	Speaker lead (3 pin, 6m)	1
AM loop aerial	1	Speaker lead (2 pin, 15m)	1
FM aerial wire	1	Screws	6
Remote control (SE-R0117)	1	Prevention rubbers	25
Batteries (AAA)	2		

• Designs and specifications are subject to change without notice.

TOSHIBA



J2D20401A 03/10 U

